

Wave Optics

Optics that derives from Maxwell's equations and the superposition principle for electromagnetic fields.

$$\left\{ \begin{array}{l} \oiint_S \vec{D} \cdot d\vec{s} = Q_f \quad \vec{D} = \epsilon_0 \vec{E} + \vec{P} = \epsilon \epsilon_0 \vec{E} \\ \oint_C \vec{E} \cdot d\vec{l} = - \frac{d}{dt} \iint_{S_L} \vec{B} \cdot d\vec{s} \\ \oiint_S \vec{B} \cdot d\vec{s} = 0 \\ \oint_C \vec{B} \cdot d\vec{l} = \mu_0 \iint_{S_L} \vec{J}_f \cdot d\vec{s} + \mu_0 \frac{d}{dt} \iint_{S_L} \vec{D} \cdot d\vec{s} \end{array} \right.$$

In homogeneous materials, $Q_f = 0$, $\vec{J}_f = 0$

$$\left\{ \begin{array}{l} \nabla \cdot \vec{D} = 0 \quad \vec{D} = \epsilon_0 \vec{E} + \vec{P} = \epsilon \epsilon_0 \vec{E} \\ \nabla \times \vec{E} = - \frac{d}{dt} \vec{B} \\ \nabla \cdot \vec{B} = 0 \\ \nabla \times \vec{B} = \mu_0 \frac{d}{dt} \vec{D} \end{array} \right.$$

Wave equations for \vec{E} and \vec{B}

$$\nabla \times (\nabla \times \vec{E}) = \nabla (\nabla \cdot \vec{E}) - \nabla^2 \vec{E}$$

$$\nabla \times \left(-\frac{d}{dt} \vec{B}\right) = -\mu_0 \frac{d^2}{dt^2} \vec{D} = -\mu_0 \epsilon_0 \epsilon \vec{E}$$

From $\nabla \cdot \vec{D} = \nabla \cdot (\epsilon \epsilon_0 \vec{E}) = \epsilon \epsilon_0 \nabla \cdot \vec{E} = 0$,

$$\begin{cases} \nabla^2 \vec{E} = \epsilon \epsilon_0 \mu_0 \frac{d^2}{dt^2} \vec{E} & \text{(Wave equation)} \\ \nabla \cdot \vec{E} = 0 & \text{(Transversality relation)} \end{cases}$$

Speed of light v

$$\frac{1}{v^2} = \epsilon \epsilon_0 \mu_0 \quad v^2 = \frac{1}{\epsilon \epsilon_0 \mu_0}$$

$$v = \frac{1}{\sqrt{\epsilon}} \cdot \frac{1}{\sqrt{\epsilon_0 \mu_0}} = \frac{c}{\sqrt{\epsilon}} \equiv \frac{c}{n}$$

$$c = \frac{1}{\sqrt{\mu_0 \epsilon_0}} = 3.0 \times 10^8 \text{ m/sec (in vacuo)}$$

n : refractive index $n \equiv \sqrt{\epsilon}$

Associated \vec{B} field:

$$\nabla \times (\nabla \times \vec{B}) = \nabla(\nabla \cdot \vec{B}) - \nabla^2 \vec{B}$$

$$\nabla \times \left(\mu_0 \frac{d}{dt} \vec{D} \right) = \epsilon \epsilon_0 \mu_0 \frac{d}{dt} (\nabla \times \vec{E}) = -\epsilon \epsilon_0 \mu_0 \frac{d^2}{dt^2} \vec{B}$$

From $\nabla \cdot \vec{B} = 0$,

$$\begin{cases} \nabla^2 \vec{B} = \epsilon \epsilon_0 \mu_0 \frac{d^2}{dt^2} \vec{B} & \text{(Wave equation)} \\ \nabla \cdot \vec{B} = 0 & \text{(Transversality relation)} \end{cases}$$

Same speed as \vec{E} , not surprisingly.

Maxwell's equations at the boundary of two adjoining homogeneous media (materials)
(derived from the integral Maxwell's equation)

$$\vec{\Delta S}_1 = \hat{n} \pi r^2$$

$$\vec{\Delta S}_2 = -\hat{n} \pi r^2$$

$\delta \ll r$ so that the integration along the side surface is neglected.

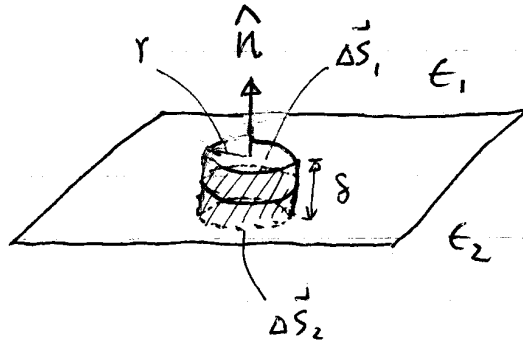

$$\oint \vec{D} \cdot d\vec{s} = \pi r^2 (\epsilon_1 \vec{E}_1 - \epsilon_2 \vec{E}_2) \cdot \hat{n} = 0$$

$$\epsilon_1 E_{1n} = \epsilon_2 E_{2n}$$

Similarly,

$$B_{1n} = B_{2n}$$

Make $\delta \ll l$,

$$\oint \vec{E} \cdot d\vec{l} = l (\vec{E}_2 - \vec{E}_1) \cdot \hat{t} = 0$$

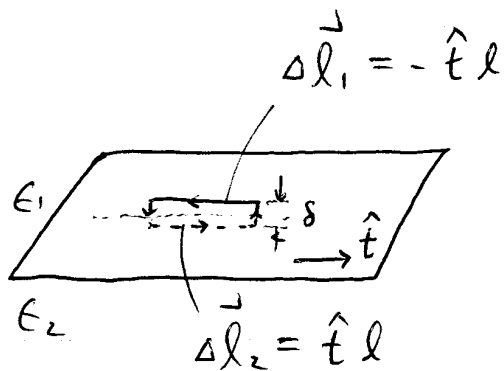

$$E_{1t} = E_{2t}$$

$$B_{1t} = B_{2t}$$

Snell's law of refraction and reflection

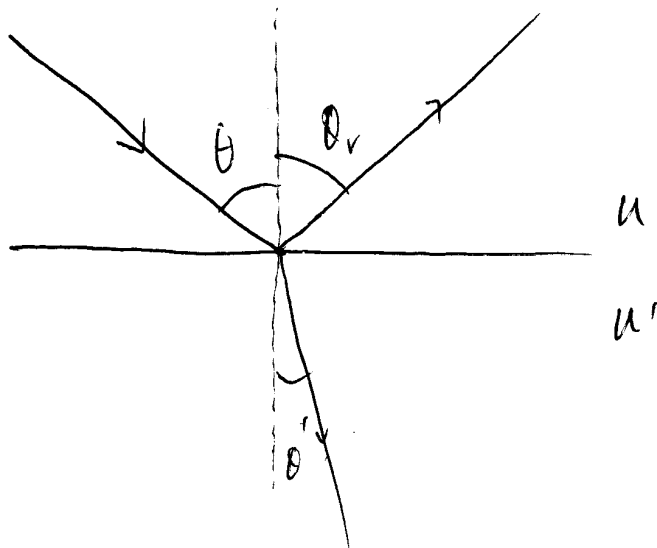

$$\theta_r = \theta \quad (\text{Reflection})$$

$$u \sin \theta = u' \sin \theta' \quad (\text{Refraction})$$

These relations, derivable from Huygen's construction or Fermat's Principle, can be derived from the boundary conditions

$$\begin{cases} E_{1t} = E_{2t} \\ B_{1t} = B_{2t} \end{cases}$$

Or, from Kirchhoff-Fresnel Integral generally

Snell's law

⇒ light travels along a straight line in a uniform medium

(i) Derivation by Fermat's Principle:

Light traverses from one point to another point by taking the path of the least time or the minimum path length.

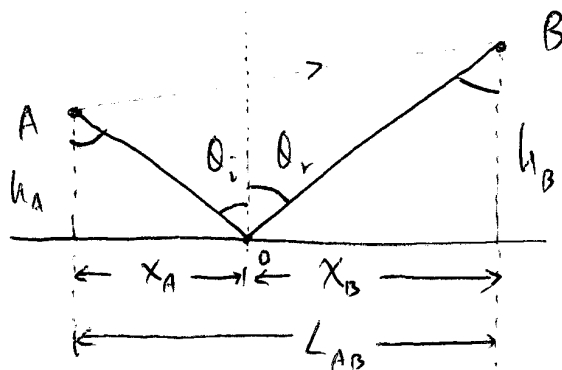

$$t = \frac{l}{v} = \frac{nl}{c}$$

"nl" = optical path length or path length

$$T_{min} \leftrightarrow \sum_i n_i l_i$$

The speed of the light in n_1 is the same we only need to find x_A so that $\overline{AO} + \overline{OB}$ is the path of the least distance

$$t(x_A) = l = \overline{OA} + \overline{OB} = \sqrt{h_A^2 + x_A^2} + \sqrt{h_B^2 + (L - x_A)^2}$$

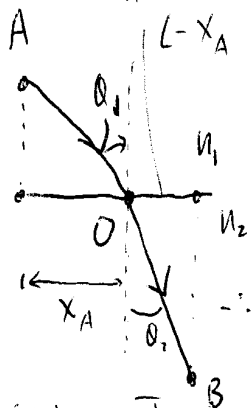

$$\frac{\partial l}{\partial x_A} = 0 = \frac{x_A}{\sqrt{h_A^2 + x_A^2}} - \frac{L - x_A}{\sqrt{h_B^2 + (L - x_A)^2}}$$

$$\frac{x_A}{\sqrt{h_A^2 + x_A^2}} = \frac{L - x_A}{\sqrt{h_B^2 + (L - x_A)^2}} \quad \text{or} \quad \boxed{\sin \theta_i = \sin \theta_r}$$

$$eT(x_A) = n_1 \overline{OA}$$

$$+ n_2 \overline{OB}$$

By the same argument,

$$\boxed{n_1 \sin \theta_i = n_2 \sin \theta_t}$$

Do it yourself

Refraction at a spherical surface and formation of image by such a spherical transmitting surface

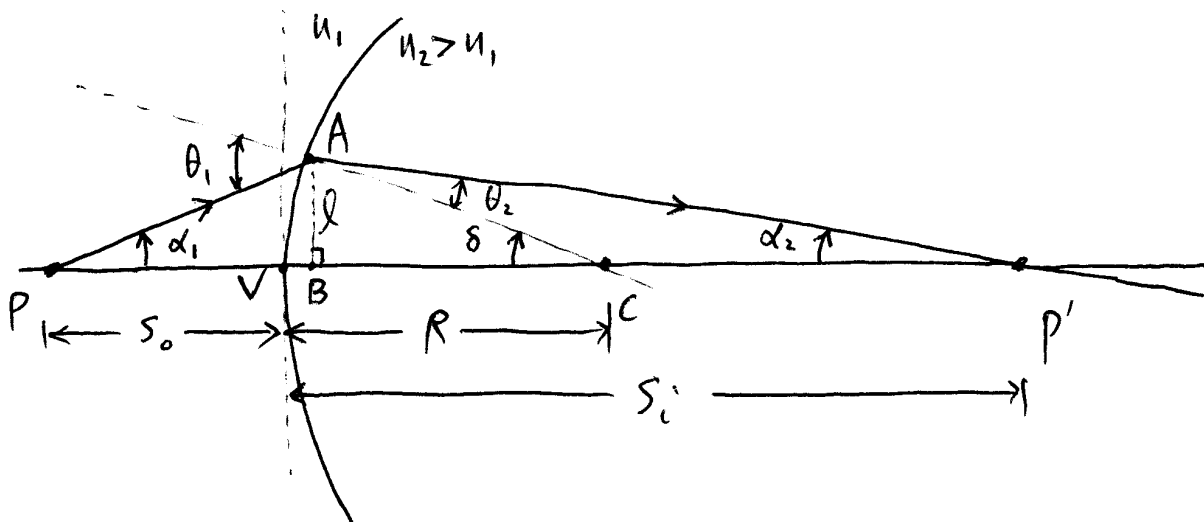

Point-like object (light source) P and the center of curvature of the spherical surface define the axis of such a simple optical system, namely, PC.

When the light cone emitted from P towards the surface is restricted to be small so that $l \ll R, s_o, s_i$ in magnitude, all angles such as $\alpha_1, \alpha_2, \delta, \theta_1, \theta_2$ are small. This is the condition of paraxial approximation.

By Snell's law, $u_1 \sin \theta_1 = u_2 \sin \theta_2$, $\Rightarrow u_1 \theta_1 \approx u_2 \theta_2$.
Since

$$\theta_1 = |\alpha_1| + |\beta| \approx \frac{l}{s_o} + \frac{l}{R}, \quad \theta_2 = |\delta| - |\alpha_2| = \frac{l}{R} - \frac{l}{s_i}$$

From $n_1 D_1 \approx n_2 D_2$,

$$\frac{n_1}{s_o} + \frac{n_2}{s_i} = \frac{n_2 - n_1}{R}$$

Since all the light emitted from P within a small cone in forward direction (paraxial approximation) converge at P', P' is called the image of the object P.

s_o : object distance
 s_i : image distance
 R : radius of curvature

Focal points of a spherical refraction surface

First focal point F_1 : a special object point whose image is at infinity

$$f_1 \equiv s_o \Big|_{s_i \rightarrow +\infty} = \frac{n_1 R}{n_2 - n_1}$$

Second focal point F_2 : a special image point that corresponds to a point-like object placed at infinity

$$f_2 \equiv s_i \Big|_{s_o \rightarrow +\infty} = \frac{n_2 R}{n_2 - n_1}$$

Refraction at a spherical surface under other circumstances

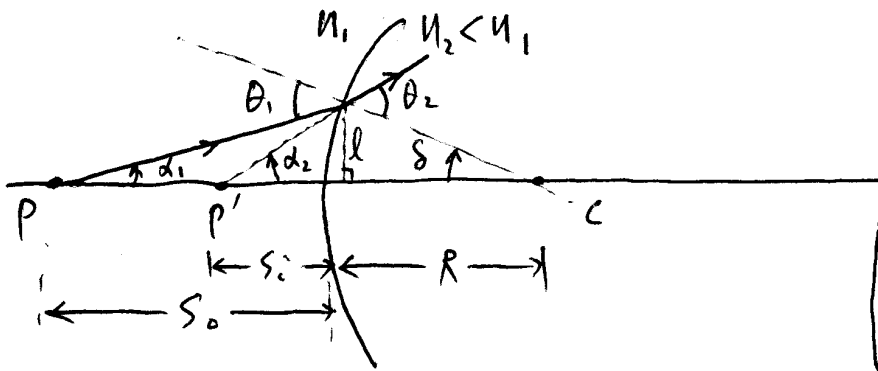

$$n_1 d_1 \approx n_2 d_2$$

$$d_2 = |d_2| + |s| = \frac{l}{s_i} + \frac{l}{R}$$

$$\frac{n_1}{s_o} + \frac{n_2}{-s_i} = \frac{n_2 - n_1}{R}$$

(virtual image)

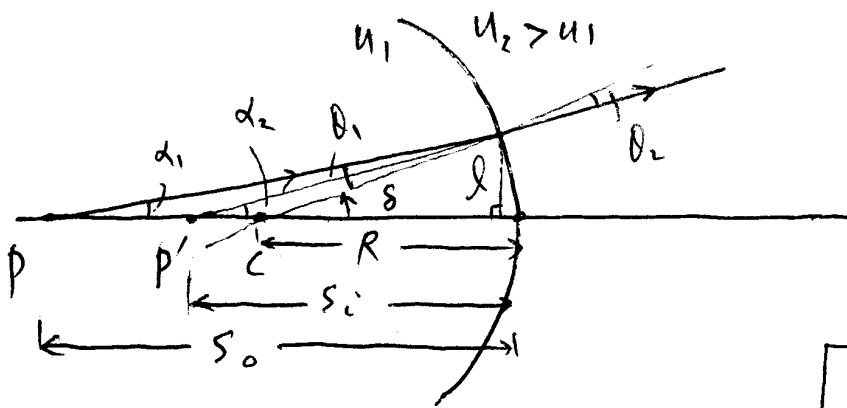

$$n_1 d_1 \approx n_2 d_2$$

$$d_1 = |s| - |d_1| = \frac{l}{R} - \frac{l}{s_o}$$

$$d_2 = |s| - |d_2| = \frac{l}{R} - \frac{l}{s_i}$$

$$\frac{n_1}{s_o} + \frac{n_2}{-s_i} = \frac{n_2 - n_1}{-R}$$

(virtual image)

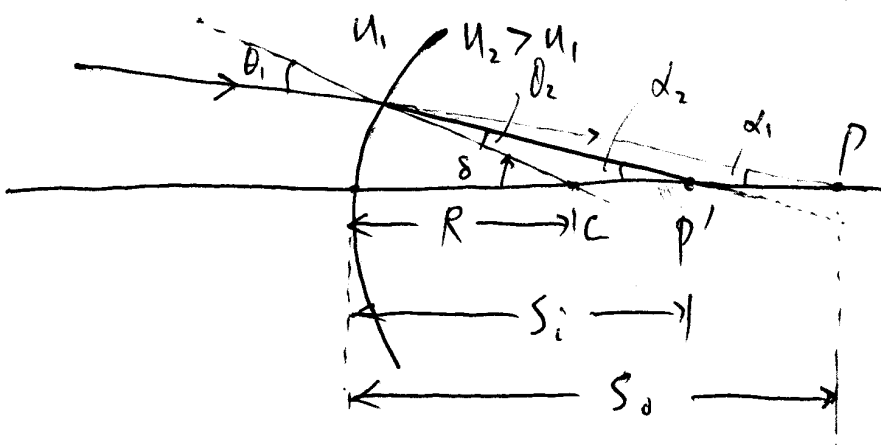

$$n_1 d_1 \approx n_2 d_2$$

$$d_1 = |s| - |d_1| = \frac{l}{R} - \frac{l}{s_o}$$

$$d_2 = |s| - |d_2| = \frac{l}{R} - \frac{l}{s_i}$$

$$\frac{n_1}{-s_o} + \frac{n_2}{s_i} = \frac{n_2 - n_1}{R}$$

One equation with sign convention to accommodate all possible situations

$$\frac{u_1}{s_o} + \frac{u_2}{s_i} = \frac{u_2 - u_1}{R}$$

s_o , s_i , and R are allowed to be either positive or negative so that one equation is sufficient.

Sign convention:

Given the location of a point-like object P , the center of the curvature C , and the intersection of the spherical surface and the system axis (along \overline{PC}) V :

- (1) If P is in front of V or the surface, s_o is positive;
If P is behind V or the surface, s_o is negative.
- (2) If C is in front of V or the surface, R is negative;
If C is behind V or the surface, R is positive.
- (3) Solving $u_1/s_o + u_2/s_i = (u_2 - u_1)/R$ for s_i :
if s_i is positive, P' is behind V , real image;
if s_i is negative, P' is in front of V , virtual image.

Special case: Refraction at a flat surface

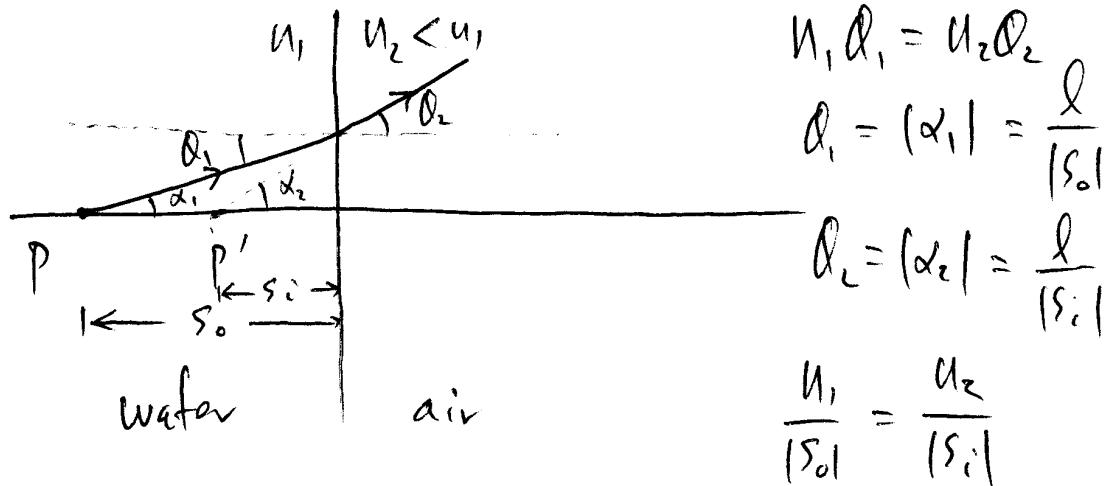

Using the general formula with $R = +\infty$,

$$\frac{n_1}{s_o} + \frac{n_2}{s_i} = 0$$

$$s_i = -\left(\frac{n_2}{n_1}\right) s_o$$

For $s_o > 0$, $s_i < 0$, virtual image, on the same side as the object. If $n_2 < n_1$, $|s_i| < |s_o|$, the image appears closer to the surface.

Example; $n_1 = 1.33$ (water), $n_2 = 1$,

$$\left| \frac{s_i}{s_o} \right| \approx \frac{1}{1.33}$$

Thin lens equation ($d \ll |R_1|, |R_2|$)

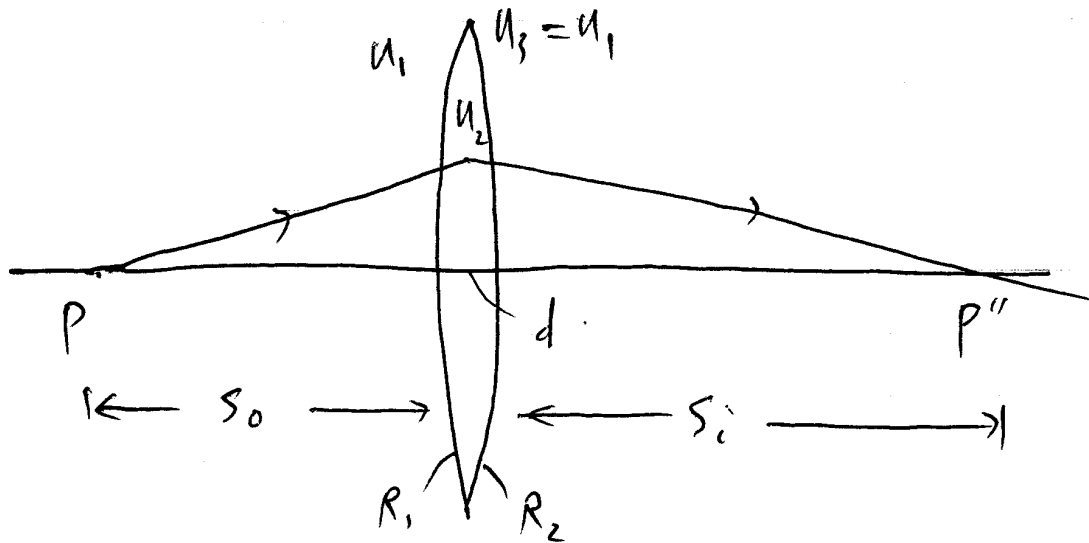

Refraction at the first surface,

$$\frac{u_1}{s_o} + \frac{u_2}{s_i'} = \frac{u_2 - u_1}{R_1} \quad (1)$$

To the second surface, the image distance after the first surface is the object distance in magnitude, but always the opposite sign,

$$s_o' = -s_i'$$

$$\frac{u_2}{s_o'} + \frac{u_1}{s_i} = \frac{u_1 - u_2}{R_2} \quad (2)$$

$$\frac{1}{s_o} + \frac{1}{s_i} = \frac{u_2 - u_1}{u_1} \left(\frac{1}{R_1} - \frac{1}{R_2} \right)$$

same sign convention

Focal points of a thin lens

First focal point f_1 : a special object point whose image is formed at infinity:

$$f_1 \equiv s_o \Big|_{s_i \rightarrow +\infty} = \frac{n_1}{n_2 - n_1} \cdot \frac{R_1 R_2}{R_2 - R_1}$$

Second focal point f_2 : a special image point that corresponds to a point-like object at infinity

$$f_2 \equiv s_i \Big|_{s_o \rightarrow +\infty} = \frac{n_1}{n_2 - n_1} \cdot \frac{R_1 R_2}{R_2 - R_1} = f_1$$

for thin lens

$$f \equiv \frac{n_1}{n_2 - n_1} \cdot \frac{R_1 R_2}{R_2 - R_1} = f_1 = f_2$$

Thin lens equation:

$$\frac{1}{s_o} + \frac{1}{s_i} = \frac{1}{f}$$
$$f = \frac{n_1}{n_2 - n_1} \cdot \frac{R_1 R_2}{R_2 - R_1}$$

Converging lenses : $f > 0$

Diverging lenses : $f < 0$

Examples :

Bi-convex lens

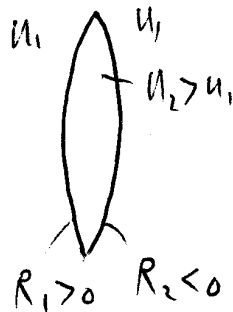

$$f = \frac{u_1}{u_2 - u_1} \cdot \frac{R_1 R_2}{R_2 - R_1} > 0$$

Plano-convex lens

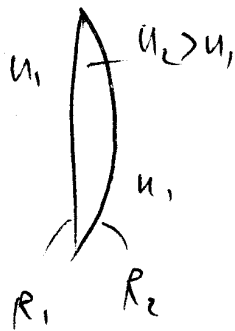

$$f = \frac{u_1}{u_2 - u_1} \cdot \frac{R_1 R_2}{R_2 - R_1}$$
$$= - \frac{u_1 R_2}{u_2 - u_1} > 0$$

Bi-concave lens

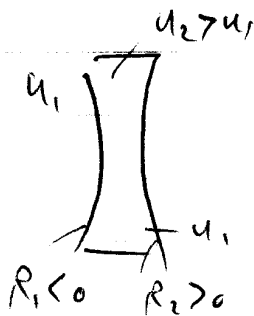

$$f = \frac{u_1}{u_2 - u_1} \cdot \frac{R_1 R_2}{R_2 - R_1} < 0$$

Meniscus lens
(positive)

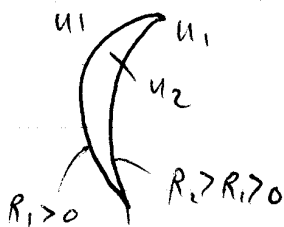

$$f = \frac{u_1}{u_2 - u_1} \cdot \frac{R_2 R_1}{R_2 - R_1} > 0$$

Graphic construction of images of small objects and linear magnification

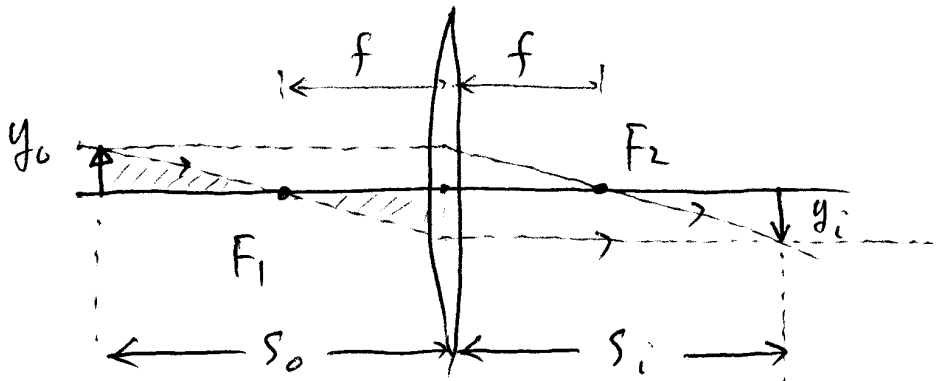

Magnification with sign (inverted or not)

$$M \equiv \frac{y_i}{y_0} = -\frac{f}{s_0 - f} = -\frac{s_i'}{s_0} < 0, \text{ inverted image}$$

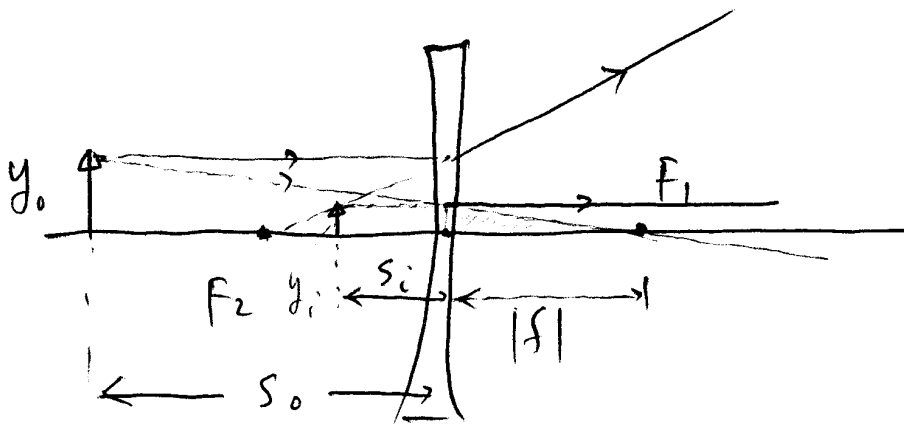

$$M \equiv \frac{y_i}{y_0} = \frac{-f}{s_0 - f} = -\frac{s_i'}{s_0} > 0, \text{ un-inverted}$$

Reflection from a spherical surface and formation of image by such a reflecting surface

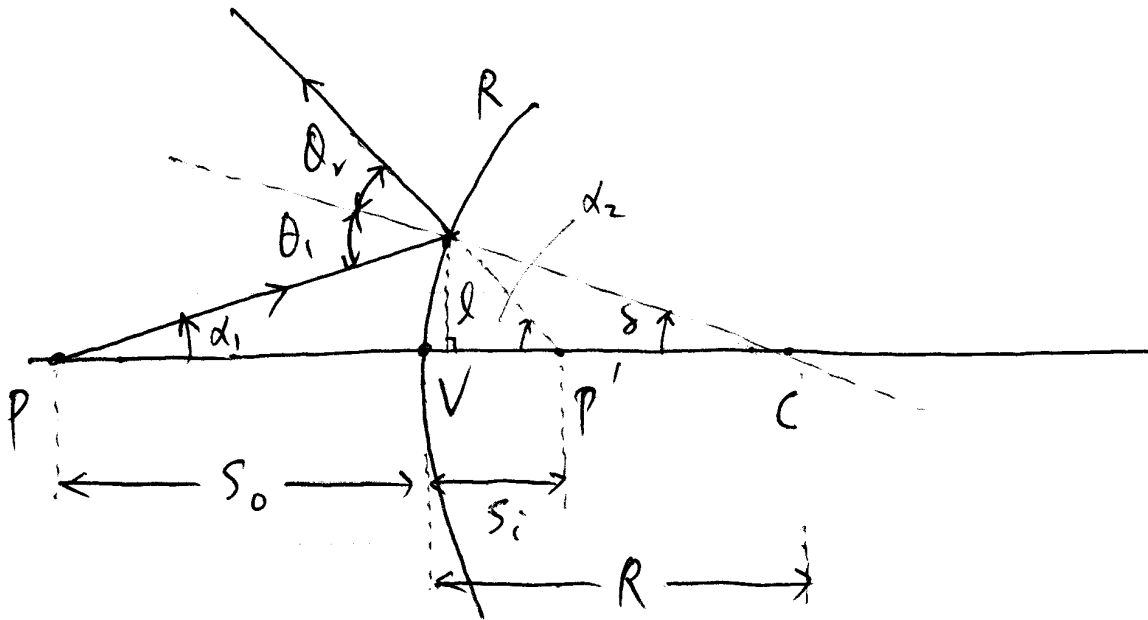

By Snell's reflection law, $\theta_i = \theta_r$

$$\theta_i = |\alpha_1| + |\delta| = \frac{l}{s_o} + \frac{l}{R} \quad , \quad \theta_r = |\alpha_2| - \delta = \frac{l}{|s_i|} - \frac{l}{R}$$

$$\frac{1}{s_o} - \frac{1}{|s_i|} = -\frac{2}{R}$$

$$\Rightarrow \frac{1}{s_o} + \frac{1}{s_i} = -\frac{2}{R}$$

- (1) If P is in front of V, $s_o > 0$
- (2) If C is behind V, $R > 0$
- (3) If $s_i > 0$, P' is in front of V;
If $s_i < 0$, P' is behind V, virtual!

Special case: reflection from a flat mirror ($R = \pm\infty$)

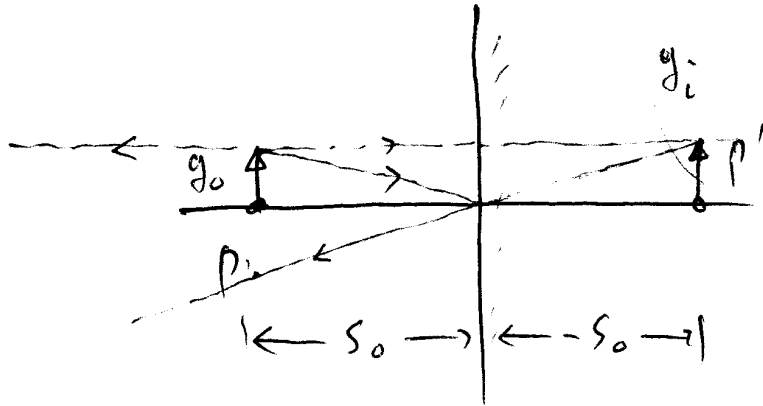

$$M = \frac{y_i}{y_0} = -\frac{s_i}{s_0}$$

Focal points of a spherical mirror:

First focal point F_1 :

$$f_1 \equiv s_0 \Big|_{s_i = \infty} = -\frac{R}{2}$$

Second focal point F_2

$$f_2 \equiv s_i \Big|_{s_0 = \pm\infty} = -\frac{R}{2}$$

So F_1 & F_2 overlap:

$$M = \frac{y_i}{y_0} = -\frac{s_i}{s_0}$$

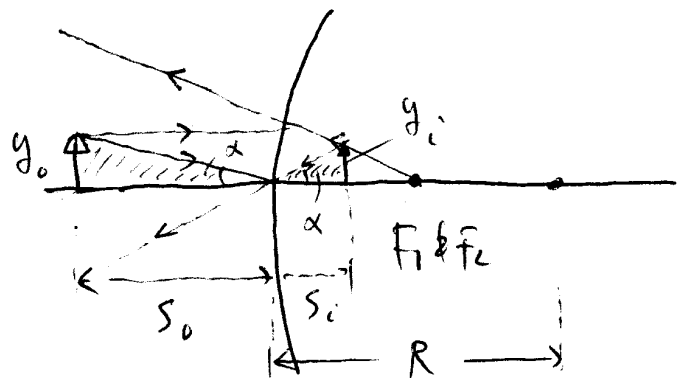

Simple optical instruments that help observation with human eyes

Working of a human eye: Adjustable lens (f_2)

$$f_{\min} = 14 \text{ mm} \quad (\text{strained}) \quad \text{(a) } s_o = d_o = 25 \text{ cm}$$

$$f_{\max} = 17 \text{ mm} \quad (\text{relaxed}) \quad \text{(i) } s_o = \infty$$

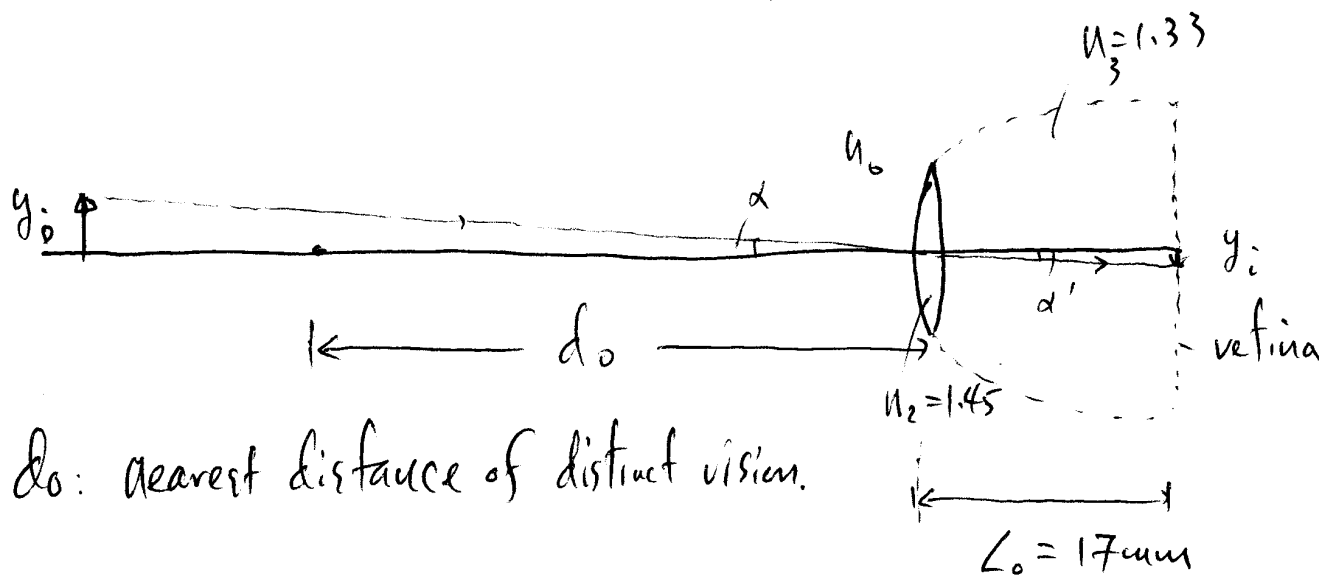

d_o : nearest distance of distinct vision.

$$L_o = 17 \text{ mm}$$

The adjustable focal length is such that any object placed between $d_o = 25 \text{ cm}$ and infinity can form a sharp image on the plane of retina. d_o is the nearest distance of distinct vision.

The linear size of an object y_o appears to be solely determined

$$y_i = L_o \alpha' = \left(\frac{n_o}{n_3} \right) \cdot L_o \alpha$$

by the angular span of the object α , regardless of s_o #

Magnifying glass (converging lens)

Simplest optical instrument for viewing small objects

When directly viewing a small object of height y_0 , the largest angular span is achieved when it is placed at the nearest distance of distinct vision d_0 .

$$\alpha_0 = \frac{y_0}{d_0}$$

When viewing a same small object through a converging lens with the focal length $f \ll d_0$, one can form a virtual image of the object by placing y_0 between the first focal point and the lens:

$$s_i = \frac{f \cdot s_o}{s_o - f}$$

By making $s_o \rightarrow f$, s_i is pushed to or beyond d_0 .
Let $s_i = -d_0$. The linear magnification

$$M = -\frac{s_i}{s_o} = \frac{-s_i}{\left(\frac{f \cdot s_i}{s_i - f}\right)} = \frac{f - s_i}{f} = 1 + \frac{d_0}{f}$$

The angular span now is

$$\alpha = \frac{y_i}{d_0} = \frac{y_i}{y_0} \frac{y_0}{d_0} = \left(1 + \frac{d_0}{f}\right) \cdot \alpha_0$$

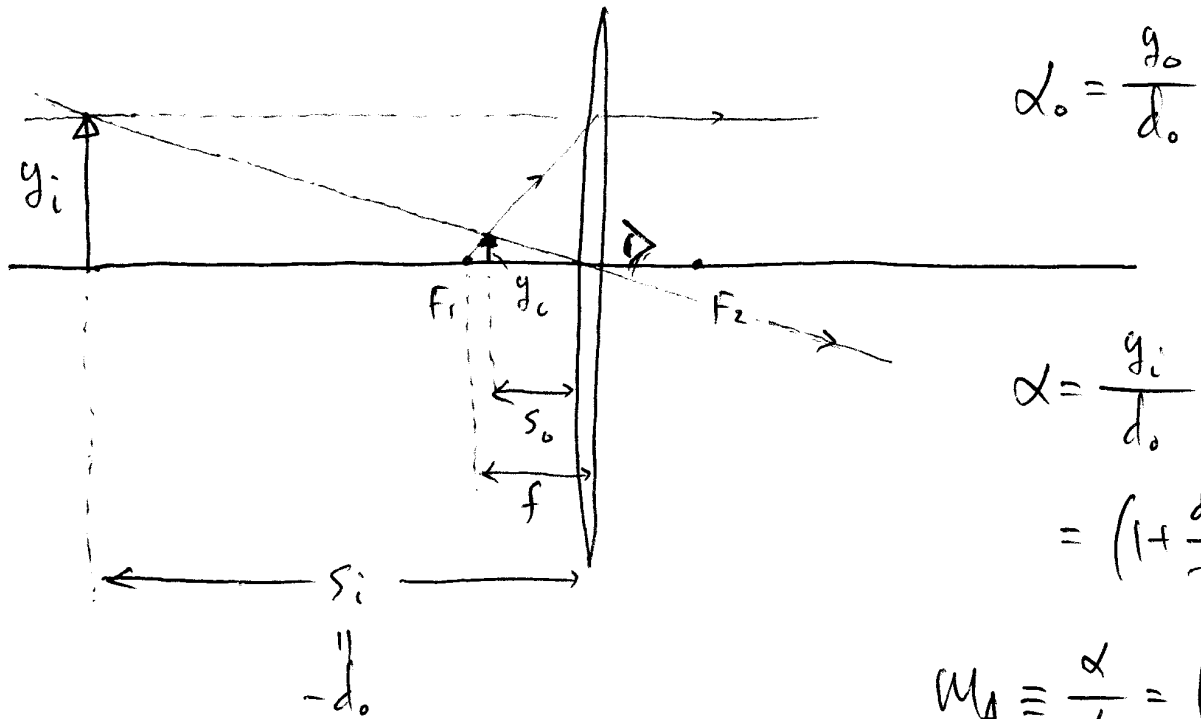

$$\alpha_o = \frac{y_o}{d_o}$$

$$\alpha = \frac{y_i}{d_o}$$

$$= \left(1 + \frac{d_o}{f}\right) \cdot \alpha_o$$

$$M_A \equiv \frac{\alpha}{\alpha_o} = 1 + \frac{d_o}{f} \approx \frac{d_o}{f}$$

Microscope. (a combination of two "converging" lenses)

Instrument for viewing very small objects

A microscope uses a combination of two "converging" lenses. The first lens forms a real, enlarged image; the second lens is used as a magnifying glass.

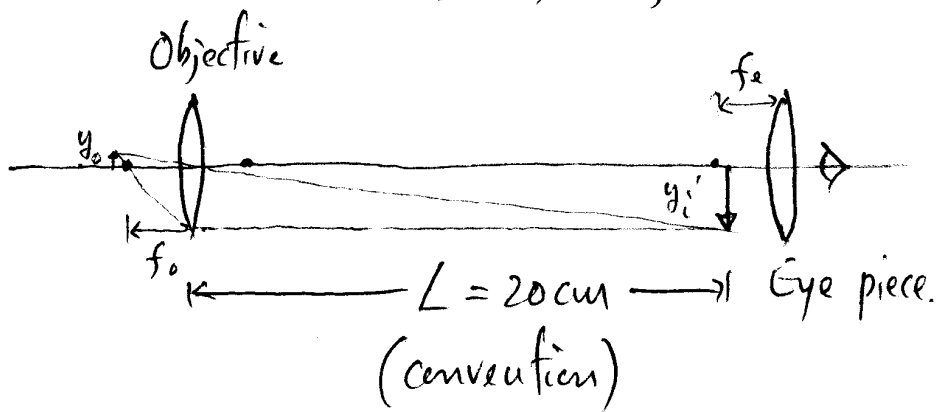

$$\alpha_o = \frac{y_o}{d_o}$$

$$\alpha = \frac{d_o}{f_e} \cdot \frac{y_i'}{d_o}$$

$$= \left(\frac{d_o}{f_e}\right) \left(\frac{L}{f_o}\right) \cdot \alpha_o$$

" " "

10X 10X

Astronomical telescope: (a combination of two "converging" lens)

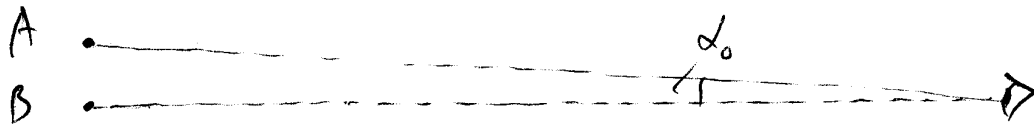

With a large focal length objective of f_o , followed by an eye piece (magnifying glass) with f_e

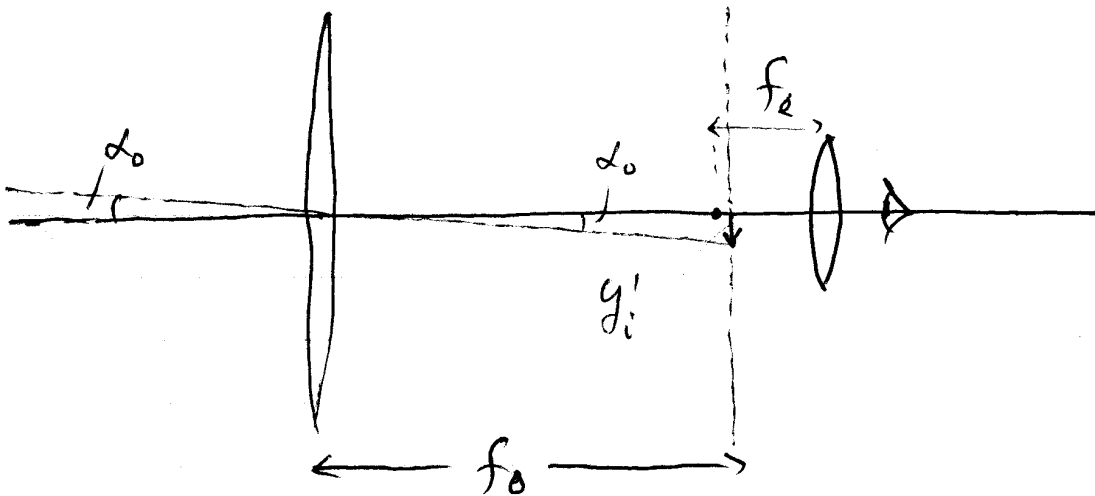

$$\alpha = \frac{d_o}{f_e} \cdot \frac{y_i'}{d_o} = \left(\frac{f_o}{f_e} \right) \cdot \alpha_0$$

Angular magnification

$$M_A \equiv \frac{\alpha}{\alpha_0} = \frac{f_o}{f_e}$$

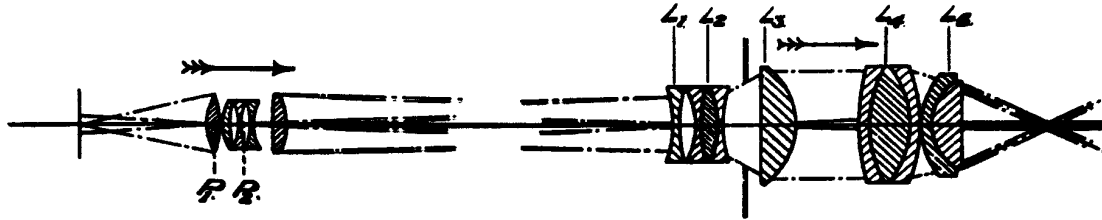

Figure 1. Microscope system discussed by H.D. Taylor, which includes a five element flat field anastigmatic objective and an inside focus wide-angle eyepiece. The eyepiece consists of five groups of lenses, L1 through L5.¹¹

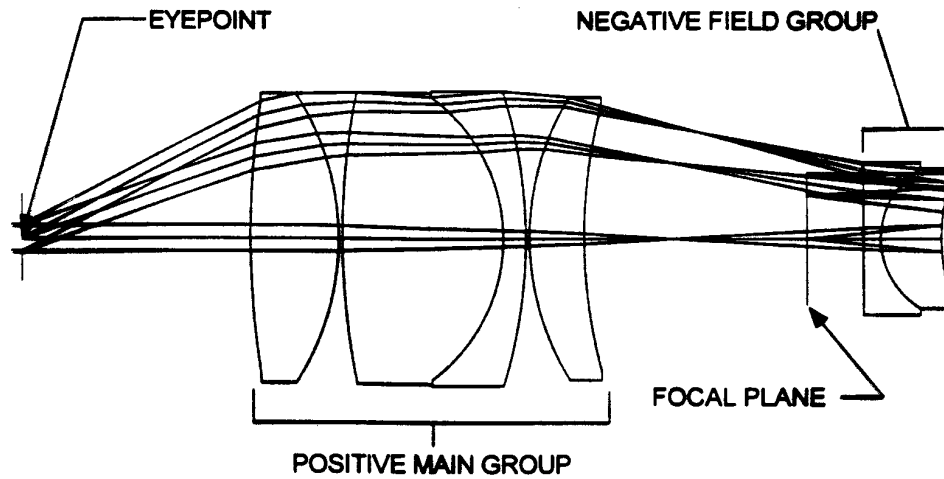

Figure 2. 10-mm, 55° full field-of-view, $f/5$ inside focus eyepiece. The term “inside focus” refers to the fact that the focal plane is located inside the eyepiece.

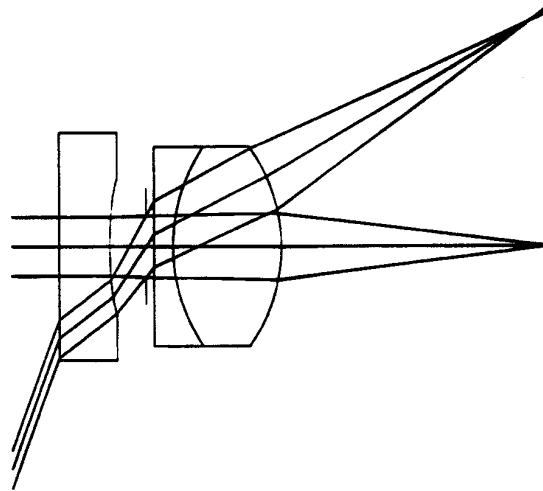

Figure 1. 1.0 mm EFL. 140° full field-of-view, f/4.025, endoscope objective.

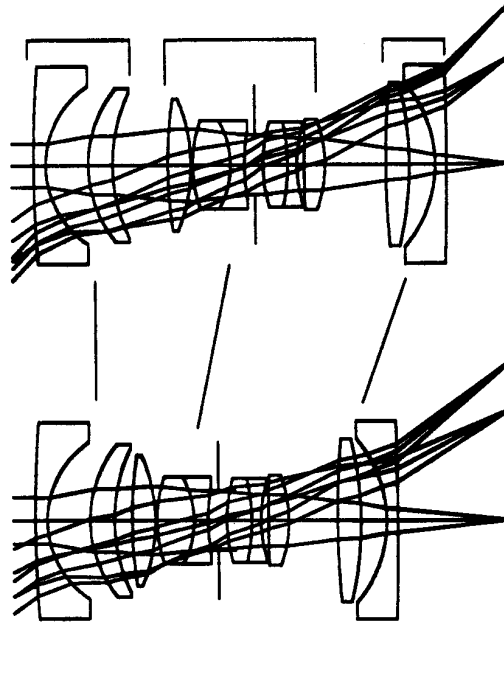
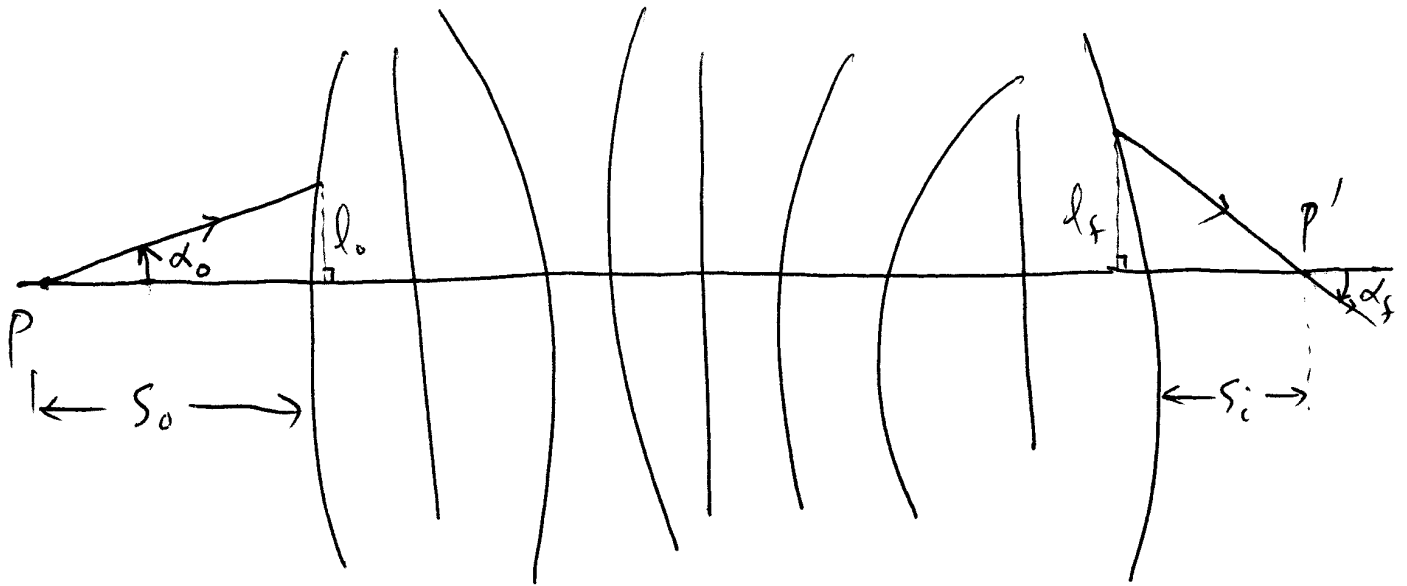

Figure 1. 21.4–29.5 mm f/3.6–f/4.6 zoom lens for a compact 35-mm camera.

Matrix formulation for thick lenses and lens systems



$$s_o = \frac{l_o}{\alpha_o}, \quad s_i = -\frac{l_f}{\alpha_f}$$

If we know how $\{l_f, \alpha_f\}$ is related to $\{l_o, \alpha_o\}$ as a result of refraction and translation

$$\begin{pmatrix} l_f \\ \alpha_f \end{pmatrix} = \begin{pmatrix} A & B \\ C & D \end{pmatrix} \begin{pmatrix} l_o \\ \alpha_o \end{pmatrix}$$

then we can find the image

$$s_i = -\frac{l_f}{\alpha_f} = -\frac{Al_o + B\alpha_o}{Cl_o + D\alpha_o} = -\frac{As_o + B}{Cs_o + D}$$

Sign convention for l & α

Let the x-axis be the system axis, and the positive x-direction be the propagating direction of the light ray.

- (1) On the upper plane, $l > 0$;
on the lower plane, $l < 0$.
- (2) $\alpha > 0$ if the light ray propagates upward
 $\alpha < 0$ if the light ray propagates downward.

Refraction at a spherical surface and refraction matrix R

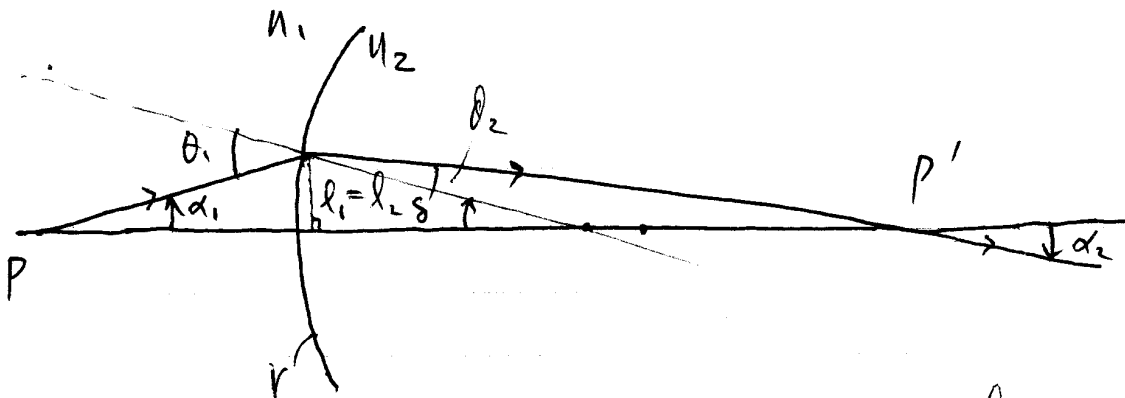

$$n_1 \theta_1 = n_2 \theta_2, \quad \theta_1 = \alpha_1 + \delta = \alpha_1 + \frac{l_1}{r}$$

$$\theta_2 = \delta - (-\alpha_2) = \alpha_2 + \frac{l_1}{r}$$

$$\Rightarrow \alpha_2 = -\frac{n_2 - n_1}{n_2 r} l_1 + \frac{n_1}{n_2} \alpha_1, \quad l_2 = l_1$$

$$\begin{pmatrix} l_2 \\ \alpha_2 \end{pmatrix} = \begin{pmatrix} 1 & 0 \\ -\frac{n_2 - n_1}{n_2} \frac{1}{r} & \frac{n_1}{n_2} \end{pmatrix} \begin{pmatrix} l_1 \\ \alpha_1 \end{pmatrix}$$

$$R_{21} \equiv \begin{pmatrix} 1 & 0 \\ -\frac{n_2 - n_1}{n_2 r} & \frac{n_1}{n_2} \end{pmatrix} \quad (\text{refraction matrix})$$

Translation Matrix $T(d)$

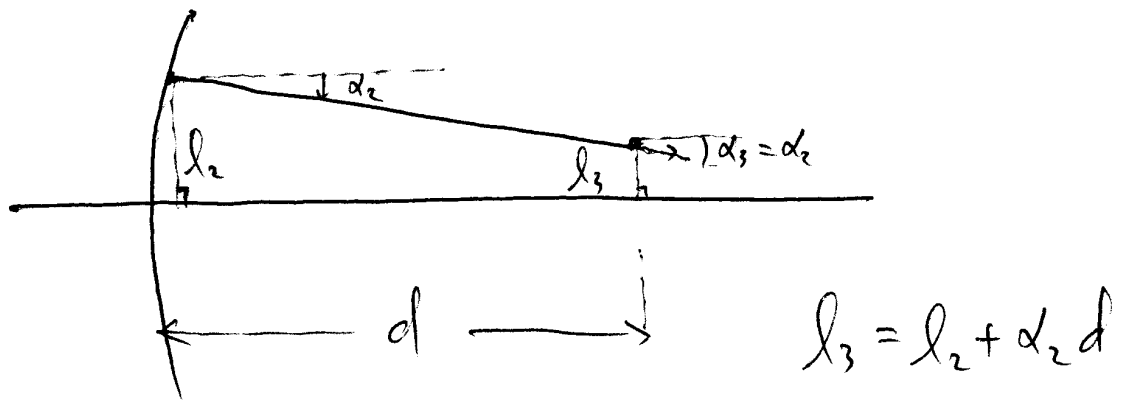

$$\begin{pmatrix} l_3 \\ \alpha_3 \end{pmatrix} = \begin{pmatrix} 1 & d \\ 0 & 1 \end{pmatrix} \begin{pmatrix} l_2 \\ \alpha_2 \end{pmatrix}, \quad T(d) = \begin{pmatrix} 1 & d \\ 0 & 1 \end{pmatrix}$$

ABCD-Matrix of a lens system

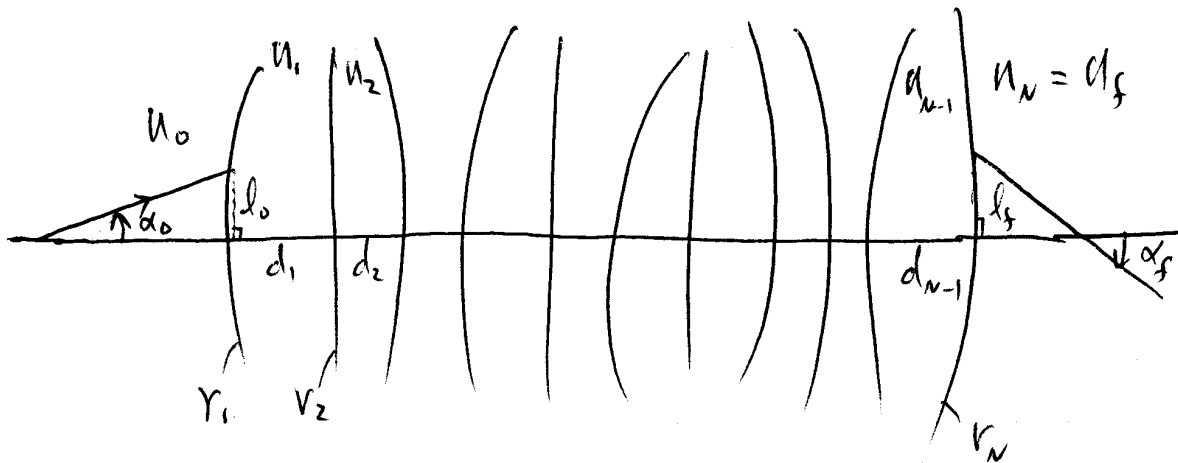

$$\begin{pmatrix} l_f \\ \alpha_f \end{pmatrix} = R_{N,N-1} T_{N-1} R_{N-1,N-2} T_{N-2} \cdots R_{21} T_1 R_{10} \begin{pmatrix} l_0 \\ \alpha_0 \end{pmatrix} \equiv \begin{pmatrix} A & B \\ C & D \end{pmatrix} \begin{pmatrix} l_0 \\ \alpha_0 \end{pmatrix}$$

$$\begin{pmatrix} A & B \\ C & D \end{pmatrix} \equiv R_{N,N-1} T_{N-1} R_{N-1,N-2} \cdots R_{21} T_1 R_{10}$$

$$\det \begin{vmatrix} A & B \\ C & D \end{vmatrix} = AD - BC = \det |R_{N,N-1}| \cdot \det |T_{N-1}| \cdots \det |R_{10}|$$

Since $\det |R_{j,j-1}| = \frac{n_{j-1}}{n_j}$, $\det |T_j| = 1$

$$\boxed{AD - BC = \frac{n_0}{n_N} = \frac{n_0}{n_f}}$$

Matrix for thick lens & thin lens

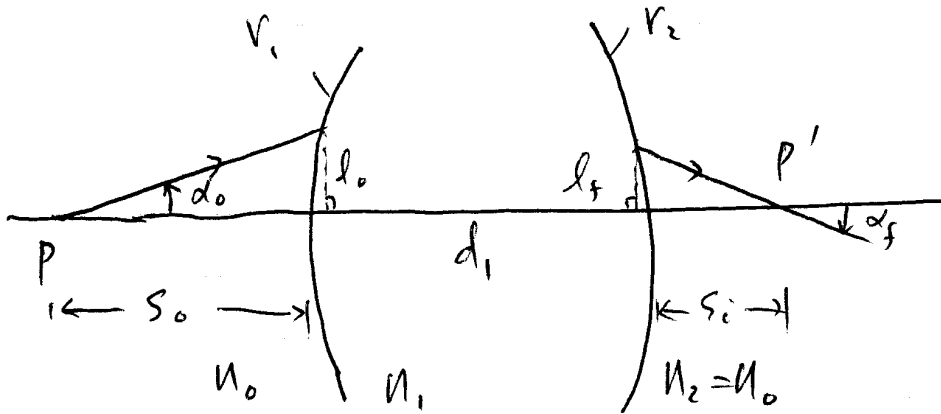

$$\begin{pmatrix} l_f \\ \alpha_f \end{pmatrix} = R_{21} T_1 R_{10} \begin{pmatrix} l_0 \\ \alpha_0 \end{pmatrix} = \begin{pmatrix} 1 & 0 \\ -\frac{n_2 - n_1}{n_2 r_2} & \frac{n_1}{n_2} \end{pmatrix} \begin{pmatrix} 1 & d_1 \\ 0 & 1 \end{pmatrix} \begin{pmatrix} 1 & 0 \\ -\frac{n_1 - n_0}{n_1 r_1} & \frac{n_0}{n_1} \end{pmatrix}$$

$$= \begin{pmatrix} 1 - \frac{d_1}{r_1} \frac{n_1 - n_0}{n_1} & \frac{n_0}{n_1} d_1 \\ -\frac{n_2 - n_0}{n_0} \left(\frac{1}{r_1} - \frac{1}{r_2} \right) - \frac{d_1 (n_1 - n_0)^2}{n_1 n_0 r_1 r_2} & 1 + \frac{d_1}{r_2} \frac{n_1 - n_0}{n_1} \end{pmatrix}$$

$$= \begin{pmatrix} A & B \\ C & D \end{pmatrix}$$

Thick lens

Thin lens matrix ($d/v \ll 1$)

$$\begin{pmatrix} l_f \\ \alpha_f \end{pmatrix} = \begin{pmatrix} 1 & 0 \\ -\frac{1}{f} & 1 \end{pmatrix} \begin{pmatrix} l_o \\ \alpha_o \end{pmatrix}$$

$$\begin{pmatrix} A & B \\ C & D \end{pmatrix}_{\text{Thin lens}} = \begin{pmatrix} 1 & 0 \\ -\frac{1}{f} & 1 \end{pmatrix}$$

From the ABCD-matrix

$$s_i = -\frac{A s_o + B}{C s_o + D} = -\frac{s_o}{-\frac{s_o}{f} + 1} = -\frac{f s_o}{f - s_o}$$

or

$$\frac{1}{s_i} = -\frac{f - s_o}{f \cdot s_o} = -\frac{1}{s_o} + \frac{1}{f}$$

$$\boxed{\frac{1}{s_o} + \frac{1}{s_i} = \frac{1}{f}}$$

Cardinal points (planes) and graphical construction of images by an optical system

$$\begin{pmatrix} l_s \\ \alpha_s \end{pmatrix} = \begin{pmatrix} A & B \\ C & D \end{pmatrix} \begin{pmatrix} l_o \\ \alpha_o \end{pmatrix} = M \begin{pmatrix} l_o \\ \alpha_o \end{pmatrix}, \quad n_o \neq n_s$$

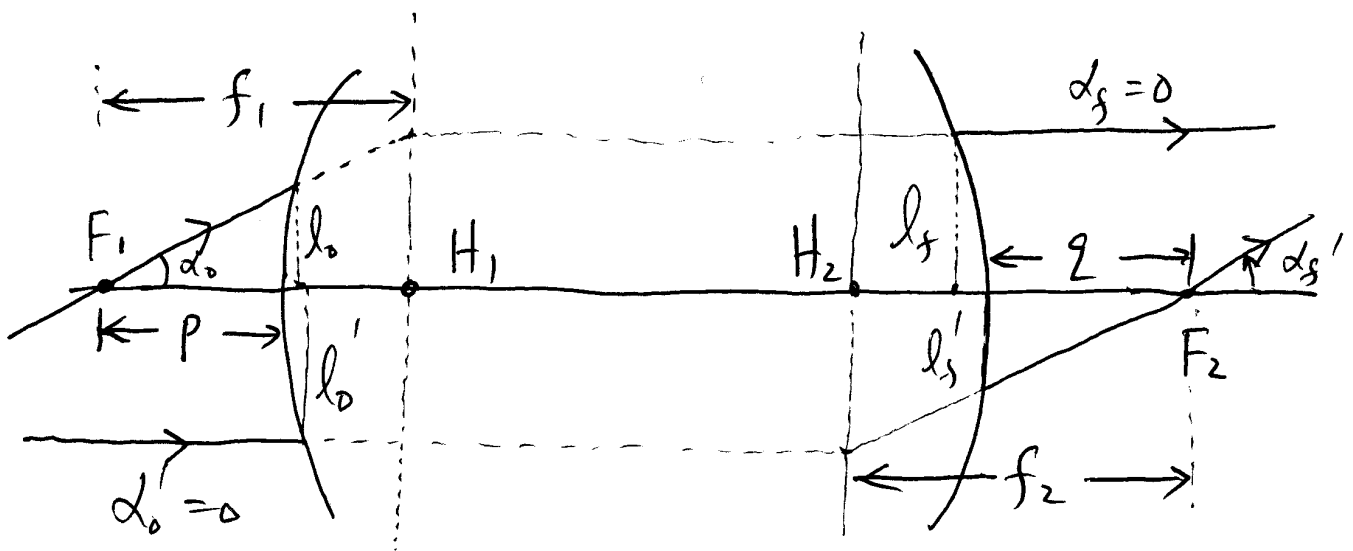

F_1, F_2 : system focal points
 H_1, H_2 : principal points

Location of F_1 & F_2 (relative to two end surfaces)

$$F_1: \alpha_s = 0 \Rightarrow C l_o + D \alpha_o = 0$$

$$p = \frac{l_o}{\alpha_o} = -\frac{D}{C}$$

$$F_2: \alpha_o' = 0 \Rightarrow A l_o' = l_s, \quad C l_o' = \alpha_s$$

$$q = -\frac{l_s}{\alpha_s} = -\frac{A}{C}$$

(same sign convention as s_o & s_i)

Location of H_1 & H_2 (F_1 & F_2 relative to H_1, H_2)

$$\textcircled{1} \quad f_1 \equiv \frac{l_f}{\alpha_o} = \frac{A l_o + B \alpha_o}{\alpha_o} = AP + B = -\frac{AD - BC}{C}$$

$$= -\frac{\det M}{C} = -\frac{n_o/n_f}{C}$$

$f_1 = -\frac{n_o/n_f}{C}$

$f_1 > 0$ if H_1 is on the right side of F_1 ;
 $f_1 < 0$ if H_1 is on the left side of F_1 ✖

$$\textcircled{2} \quad f_2 \equiv -\frac{\cancel{l_o'}}{\cancel{\alpha_f'}} \frac{l_o'}{\alpha_f'} = -\frac{1}{C}$$

$f_2 = -\frac{1}{C}$

$f_2 > 0$ if H_2 is on the left side of F_2
 $f_2 < 0$ if H_2 is on the right side of F_2 .

Example: Thin lens with $M = \begin{pmatrix} 1 & 0 \\ -1/f & 1 \end{pmatrix}$ $f > 0$ (or < 0)

$$P = f = f_1$$

$$Q = f = f_2$$

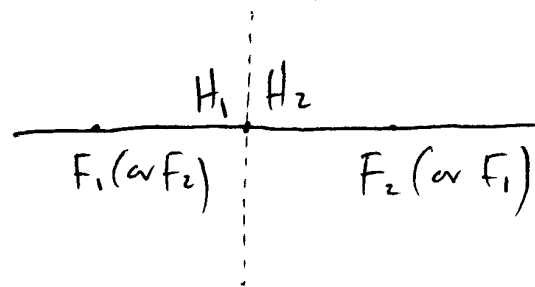

Magnification $M \equiv y_i / y_o$

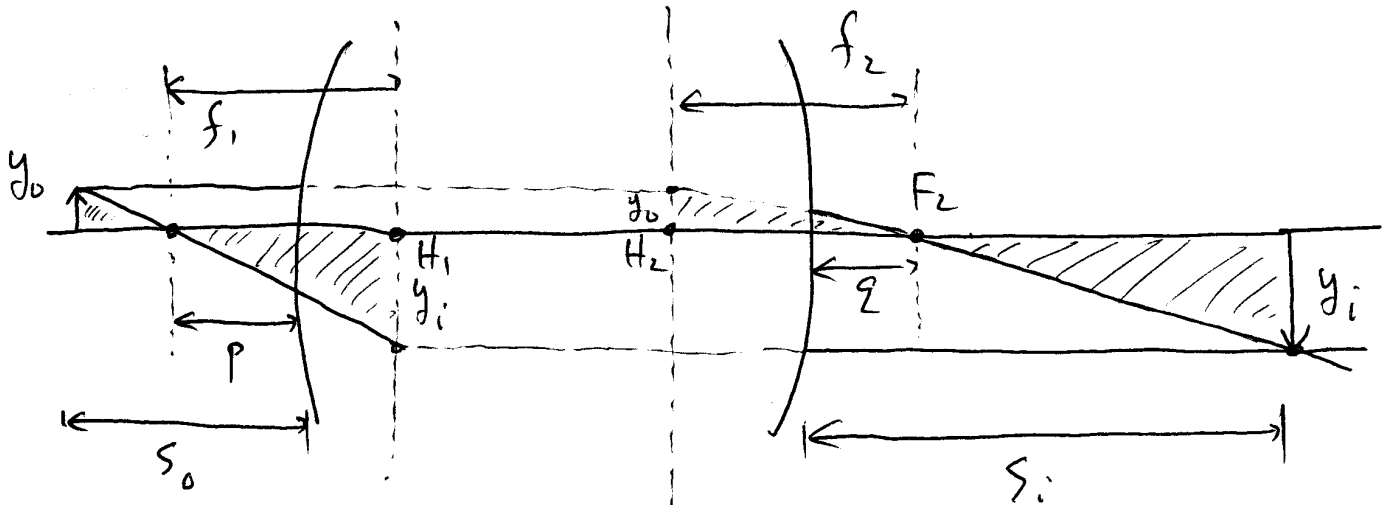

$$M \equiv \frac{y_i}{y_o} = -\frac{f_1}{s_o - p}$$

$$M \equiv \frac{y_i}{y_o} = -\frac{s_i - q}{f_2}$$

Two other cardinal points: (N_1 & N_2)

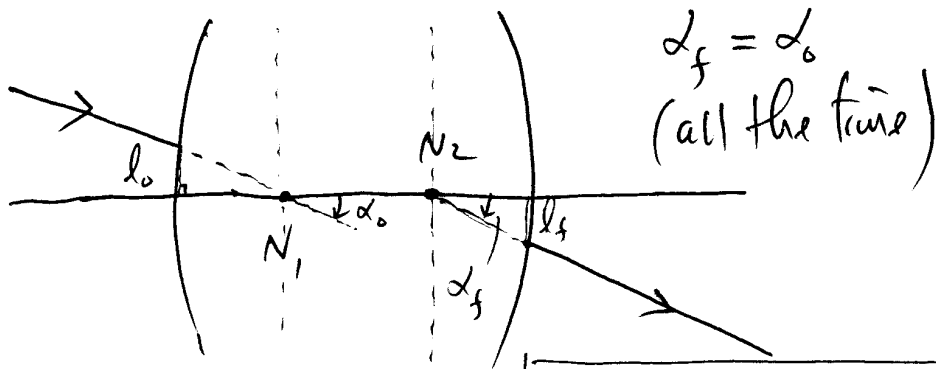

$$N_1: Cl_o + D\alpha_o = \alpha_o \Rightarrow \frac{l_o}{\alpha_o} = -\frac{p}{c} + \frac{1}{c} = p - f_2 \quad N_1$$

$$N_2: A l_o + B \alpha_o = l_s \Rightarrow -\frac{l_s}{\alpha_s} = -\frac{l_s}{\alpha_o} = q - f_2 \quad N_2$$

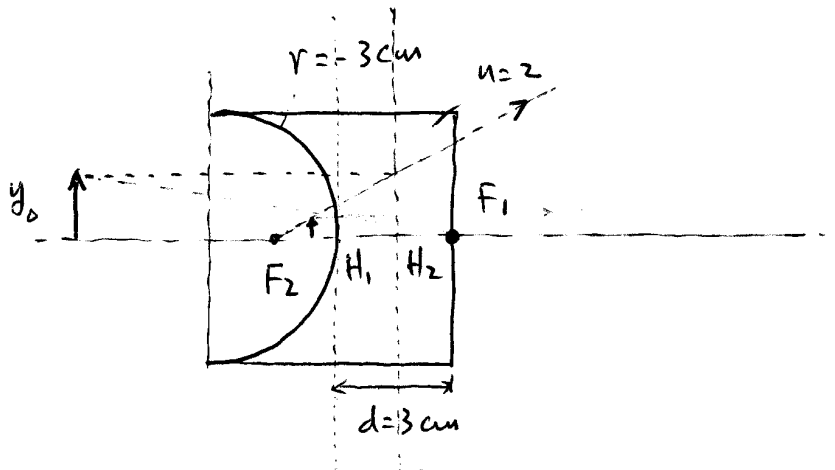

$$M = \begin{pmatrix} 1 & 0 \\ 0 & 2 \end{pmatrix} \begin{pmatrix} 1 & 3 \\ 0 & 1 \end{pmatrix} \begin{pmatrix} 1 & 0 \\ +\frac{1}{6} & \frac{1}{2} \end{pmatrix}$$

$$= \begin{pmatrix} 1 & 3 \\ 0 & 2 \end{pmatrix} \begin{pmatrix} 1 & 0 \\ \frac{1}{6} & \frac{1}{2} \end{pmatrix} = \begin{pmatrix} \frac{3}{2} & \frac{3}{2} \\ \frac{1}{3} & 1 \end{pmatrix} = \begin{pmatrix} A & B \\ C & D \end{pmatrix}$$

$$p = -\frac{D}{C} = -3 \text{ cm}$$

$$q = -\frac{A}{C} = -\frac{9}{2} = -4.5 \text{ cm}$$

$$f_1 = -\frac{1}{C} = -3 \text{ cm}$$

$$f_2 = -\frac{1}{C} = -3 \text{ cm}$$

$$M = \frac{-3}{6 - (-3)} = \frac{1}{3}$$

*

Harmonic, plane-wave electromagnetic fields

$$\vec{E}(\vec{r}, t) = \vec{E} \cos\omega \left(t - \frac{\hat{k} \cdot \vec{r}}{v} \right) = \vec{E} \cos\omega \left(t - n \frac{\hat{k}}{c} \cdot \vec{r} \right)$$

$$= \vec{E} \cos \left(\omega t - n \frac{\omega}{c} \hat{k} \cdot \vec{r} \right)$$

$$= \vec{E} \cos(\vec{k} \cdot \vec{r} - \omega t) \quad \vec{k} = n \frac{\omega}{c} \hat{k}$$

$$\vec{B}(\vec{r}, t) = \vec{B} \cos(\vec{k} \cdot \vec{r} - \omega t) \quad \text{wave-vector}$$

- Phase of a harmonic plane-wave e.m. field:

$$\phi(\vec{r}, t) = \vec{k} \cdot \vec{r} - \omega t + \phi_0$$

$\phi(\vec{r}, t) = \text{constant}$ defines a phase-front; for a plane-wave e.m. field, the phase-front is a flat plane.

- Wavelength λ : shortest distance along \hat{k} when the wave repeats:

$$\Delta \vec{r} = \hat{k} \cdot \lambda, \quad \hat{k} \cdot \Delta \vec{r} = k \cdot \lambda = 2\pi \quad \text{or} \quad \Delta \phi \Big|_{t \text{ fixed}} = 2\pi$$

$$k = n \frac{\omega}{c} = \frac{2\pi}{\lambda}$$

$$\lambda = \left(\frac{2\pi c}{\omega} \right) \frac{1}{n} = \frac{\lambda_0}{n}$$

$$\lambda_0 = \frac{2\pi c}{\omega} \quad \text{vacuum wavelength}$$

Energy flow density vector \vec{S} and intensity of an l.w.

$$\begin{aligned}\vec{S} &= \frac{1}{\mu_0} \vec{E} \times \vec{B} = \frac{\mu}{\mu_0 c} \vec{E} \times (\hat{k} \times \vec{E}) c^2 (\hat{k} \cdot \vec{r} - ct) \\ &= \frac{\mu}{\mu_0 c} \hat{k} (\vec{E} \cdot \vec{E}) c^2 (\hat{k} \cdot \vec{r} - ct) \quad \left(\vec{B} = \frac{\mu}{c} \hat{k} \times \vec{E} \right)\end{aligned}$$

$$\langle \vec{S} \rangle = \frac{\mu E^2}{2\mu_0 c} \hat{k}$$

\hat{k} is also the direction of the energy flow in isotropic material.

Intensity I :

$$I \equiv |\langle \vec{S} \rangle| = \frac{\mu}{2\mu_0 c} E^2$$

$$= \frac{\Delta W}{\Delta A} = \frac{\text{Energy flow}}{\text{Area}} \left(\frac{\text{Watt}}{\text{m}^2} \right)$$

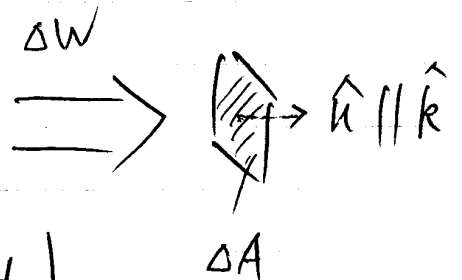

What do we observe of light with our eyes or a photo-detector?

Typically (not always, if we want to be exact), a portion of the l.m. wave is absorbed by a detector or our eyes.

As a result of absorption process, the electric field $\vec{E}(t) = \vec{E} \cos(\omega t - \phi(r))$ drives the electrons in the detector or in the eye to produce a time-varying polarization

$$\vec{p}(t) = \alpha' \vec{E} \cos(\omega t - \phi(r)) + \alpha'' \vec{E} \cos(\omega t - \phi(r) - \frac{\pi}{2})$$

↑ "Friction"

The absorbed power or its time-average is what is observed

$$\begin{aligned} \left\langle \frac{d\vec{p}}{dt} \cdot \vec{E} \right\rangle &= \left\langle -\alpha' \sin(\omega t - \phi(r)) \cdot \sin(\omega t - \phi(r)) \cdot \omega \right. \\ &\left. + \alpha'' \cos^2(\omega t - \phi(r)) \cdot \omega \right\rangle E^2 \\ &= \omega \alpha'' \frac{1}{2} E^2 \end{aligned}$$

$$\boxed{\left\langle \frac{d\vec{p}}{dt} \cdot \vec{E}(t) \right\rangle = \frac{\omega}{2} \alpha'' \cdot E^2 = (\dots) I}$$

Viewing the light with a screen or index card
or any diffusive surface



The total power emitted per unit area is proportional to the square of the induced dipole moment or polarization

$$\vec{p}(t) = (\dots) \vec{E}(t)$$

$$\Delta W_A = (\dots) |\vec{p}(t)|^2 = (\dots) \dot{E}^2 = (\dots) I$$

I : proportional to irradiance

ΔW_A : proportional to radiance

Two-beam interference

$$\vec{E}_1(\vec{r}, t) = \vec{E}_1 \cos(\omega t - \phi_1(\vec{r})) \quad I_1 = \frac{\mu}{2\mu_0 c} E_1^2$$

$$\vec{E}_2(\vec{r}, t) = \vec{E}_2 \cos(\omega t - \phi_2(\vec{r})) \quad I_2 = \frac{\mu}{2\mu_0 c} E_2^2$$

Total detected power density (brightness)

$$\begin{aligned} & \langle \vec{E}(\vec{r}, t) \cdot \vec{E}(\vec{r}, t) \rangle \\ &= \langle \vec{E}_1(\vec{r}, t) \cdot \vec{E}_1(\vec{r}, t) \rangle + \langle \vec{E}_2(\vec{r}, t) \cdot \vec{E}_2(\vec{r}, t) \rangle \\ & \quad + 2 \langle \vec{E}_1(\vec{r}, t) \cdot \vec{E}_2(\vec{r}, t) \rangle \\ &= \frac{E_1^2}{2} + \frac{E_2^2}{2} + 2 \vec{E}_1 \cdot \vec{E}_2 \cos(\phi_2(\vec{r}) - \phi_1(\vec{r})) \cdot \frac{1}{2} \end{aligned}$$

Multiplying the factor of $\mu/\mu_0 c$:

$$I \equiv \frac{\mu}{\mu_0 c} \langle \vec{E}(\vec{r}, t) \cdot \vec{E}(\vec{r}, t) \rangle$$

$$= I_1 + I_2 + 2 \sqrt{I_1 I_2} \hat{E}_1 \cdot \hat{E}_2 \cos(\phi_2(\vec{r}) - \phi_1(\vec{r}))$$

$2 \sqrt{I_1 I_2} \hat{E}_1 \cdot \hat{E}_2 \cos(\phi_2(\vec{r}) - \phi_1(\vec{r}))$ is the interference term.



Young's interference: (slit length $L_s^2 \gg \lambda L$)

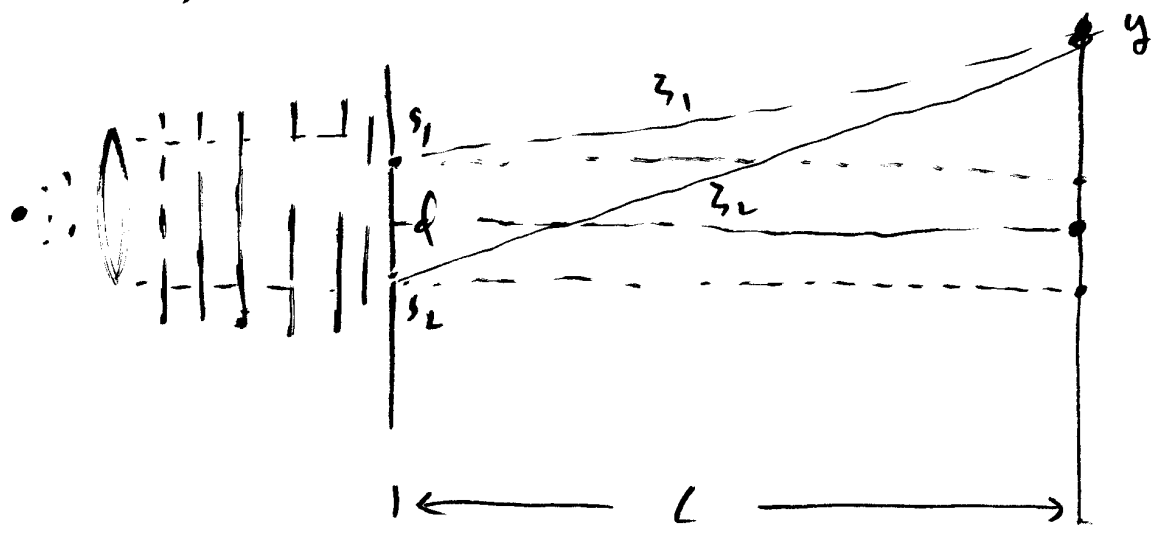

s_1, s_2 two point sources, emitting ~~light~~ cylindrical waves *

$$I(y) = I_{\text{mean}} (1 + \cos(\varphi_1(y) - \varphi_2(y)))$$

$$\begin{aligned} \Delta\varphi &= \frac{2\pi}{\lambda} n (z_2 - z_1) = \frac{2\pi}{\lambda} n \cdot \left(\sqrt{L^2 + (y+d/2)^2} - \sqrt{L^2 + (y-d/2)^2} \right) \\ &= \frac{2\pi}{\lambda} n \cdot \frac{yd}{L} \quad (L \gg y, d) \end{aligned}$$

spatial period: $\delta y \Big|_{\Delta\varphi=2\pi} = \frac{\lambda L}{nd}$

(published in 1801, done between 1797-1799)

Fresnel's prism

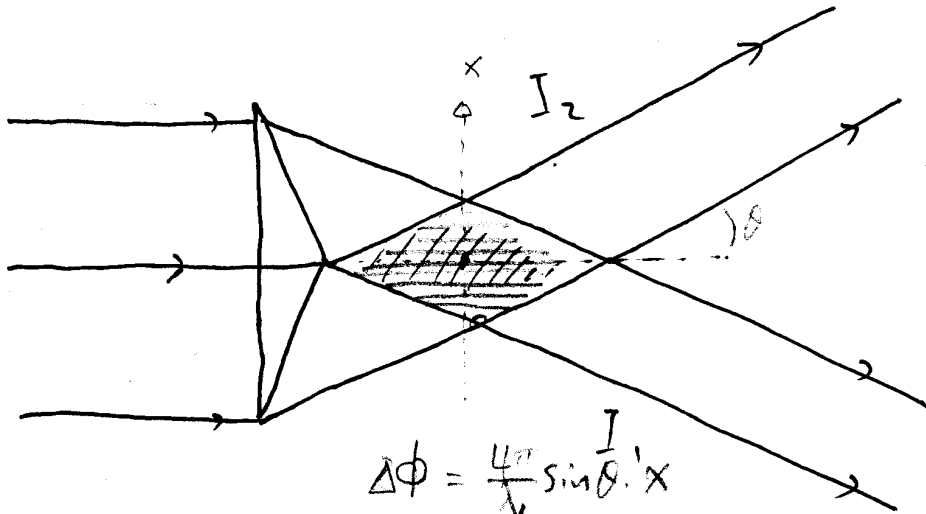

$$\Delta\phi = \frac{4\pi}{\lambda} \sin\theta \cdot x$$

$$a = \frac{\lambda}{2\sin\theta}$$

Point-source above a reflecting surface

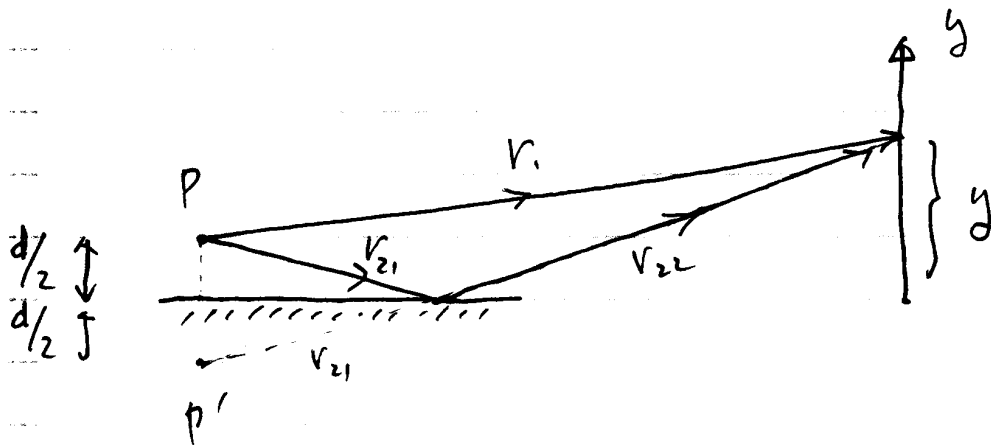

$$r_2 = r_{21} + r_{22}$$

Stokes relations:

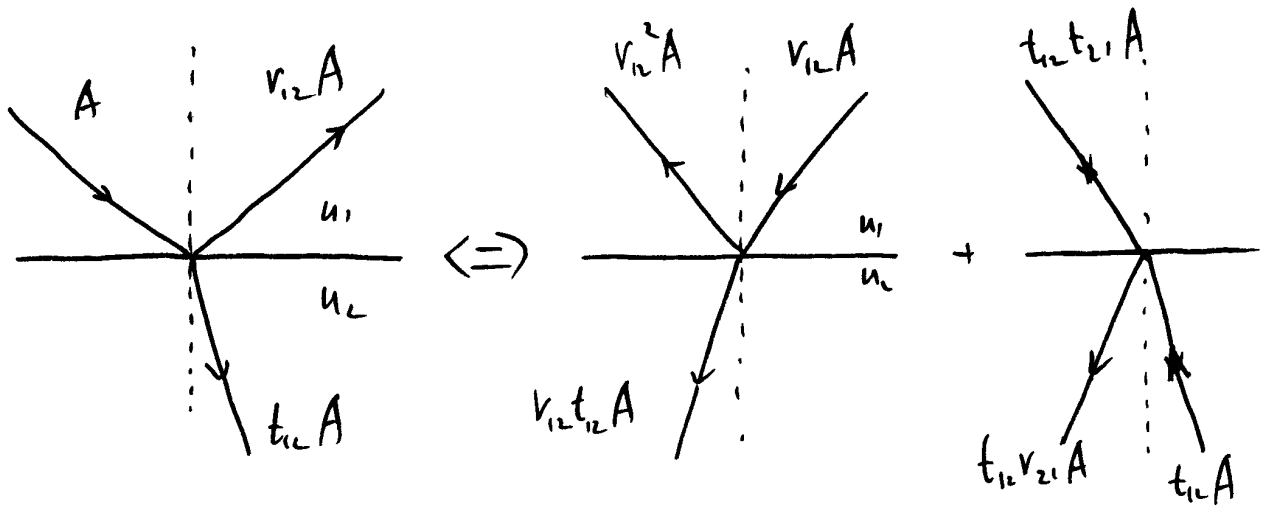

By reversing the transmitted and the reflected waves,

$$r_{12} t_{12} A + t_{12} r_{21} A = 0$$

$$r_{12}^2 A + t_{12} t_{21} A = A$$

$$r_{12} = -r_{21}$$

$$r_{12}^2 + t_{12} t_{21} = 1$$

(energy conservation)

Reflection from two nearly parallel surfaces

(Newton's rings, wedge-shaped gap, etc.)

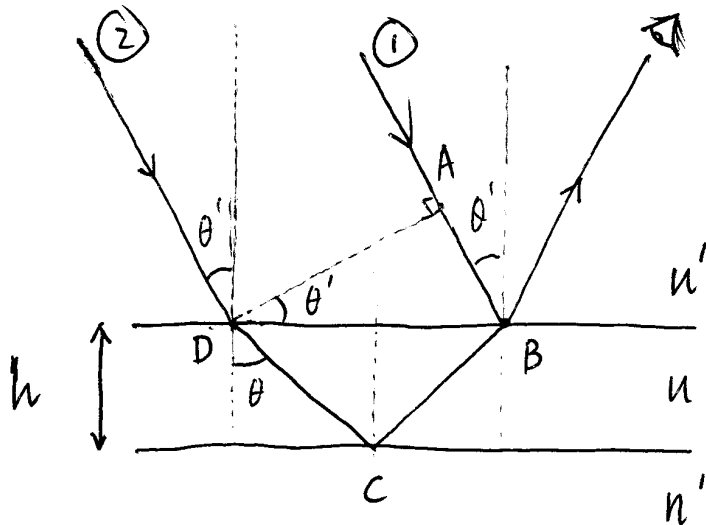

Ray (beam) (1):

$$\begin{aligned}\phi_1(\text{at } B) &= \phi_1(\text{at } A) + \frac{2\pi}{\lambda_0} n' \overline{AB} = \phi_1(\text{at } A) + \frac{2\pi}{\lambda_0} n' \sin \theta' \cdot \overline{DB} \\ &= \phi_1(\text{at } A) + \left(\frac{2\pi}{\lambda_0}\right) \cdot 2h \cdot \tan \theta \cdot n' \sin \theta'\end{aligned}$$

Ray (beam) (2)

$$\begin{aligned}\phi_2(\text{at } B) &= \phi_2(\text{at } D) + \frac{2\pi}{\lambda_0} n (\overline{DC} + \overline{CB}) = \phi_2(\text{at } D) + \frac{2\pi}{\lambda_0} \cdot 2 \cdot n \overline{DC} \\ &= \phi_2(\text{at } D) + \left(\frac{2\pi}{\lambda_0}\right) \cdot 2h \cdot \frac{n}{\cos \theta}\end{aligned}$$

$$\left. \phi_2(\text{at } B) - \phi_1(\text{at } B) \right|_{\text{spatial}} = \left(\frac{2\pi}{\lambda_0}\right) \cdot 2h \cdot n \cdot \cos \theta$$

From Stokes' relation, one of the beams experiences a π -phase shift upon reflection, but not the other one,

$$\phi_2(\text{at } B) - \phi_1(\text{at } B) = \frac{4\pi}{\lambda_0} n \cdot h \cdot \cos \theta + \pi$$

$$I = 2I_1 \left(1 + \cos(\phi_2 - \phi_1) \right)_B$$

$$= 2I_1 \left(1 - \cos \frac{4\pi h \cdot n}{\lambda_0} \cdot \cos \theta \right)$$

When $h=0$, $I(h=0)$ is zero at all wavelengths, thus the gap appears dark. As h increases, depending upon n and θ , different wavelengths may assume maximum or minimum, causing the rainbow color (soap bubbles, the gap between two glass slides)

Wedge-shaped gap:

$$I(x) = 2I \left(1 - \cos \frac{4\pi n}{\lambda_0} h(x) \cos \theta \right)$$

Separation between maxima

$$\frac{4\pi}{\lambda_0} n \cos \theta \delta h = 2\pi, \quad \delta h = \frac{\lambda_0}{2n \cos \theta}, \quad \alpha = \frac{\delta h}{\delta x} = \frac{\lambda_0}{2\delta x \cos \theta \cdot n}$$

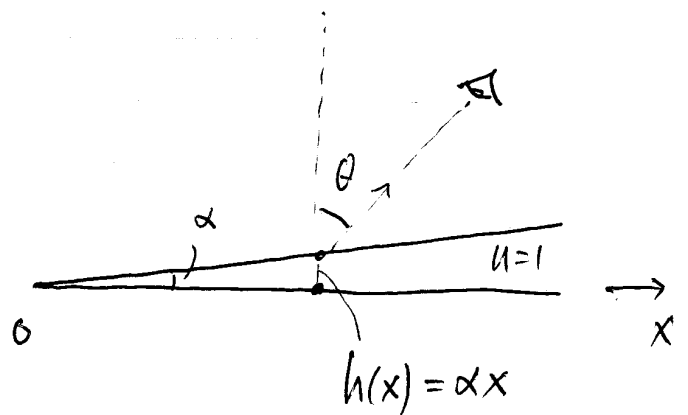

Michelson interferometer

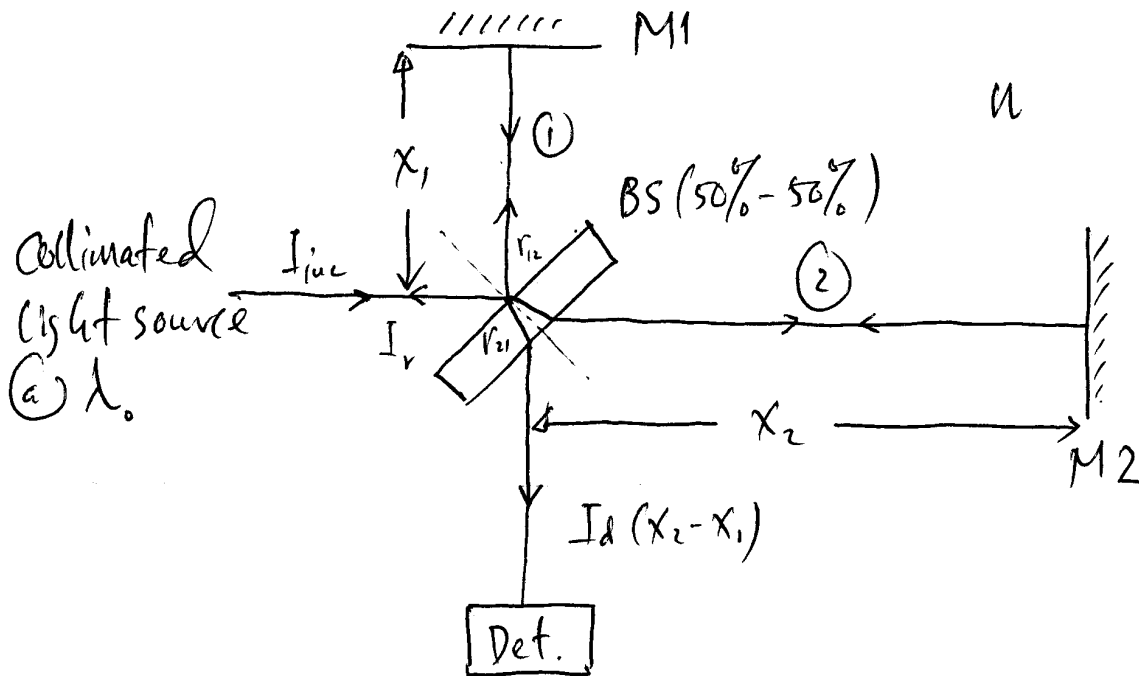

One of the two beams experiences π phase shift upon reflection but not the other one (Stokes relations),

$$\phi_2 - \phi_1 = \left(\frac{2\pi}{\lambda_0}\right) \cdot 2 \cdot \mu \cdot (x_2 - x_1) + \pi \quad (\text{for } I_d(x_2 - x_1))$$

$$I_d(x_1, x_2) = \frac{I_{inc}}{2} \left(1 - \cos \frac{4\pi\mu}{\lambda_0} (x_2 - x_1) \right)$$

$$I_v(x_1, x_2) = \frac{I_{inc}}{2} \left(1 + \cos \frac{4\pi\mu}{\lambda_0} (x_2 - x_1) \right)$$

$$I_d + I_v = I_{inc} \quad (\text{energy conservation})$$

At $x_2 = x_1$, $I_d(x_1, x_2 = x_1, t_0) = 0$ at all t_0 . Using a white light source, when $I_d = 0$, then $x_2 = x_1$. At this point, looking into Michelson interferometer, one sees a black center

Michelson interferometer and reflection from two nearly parallel surfaces

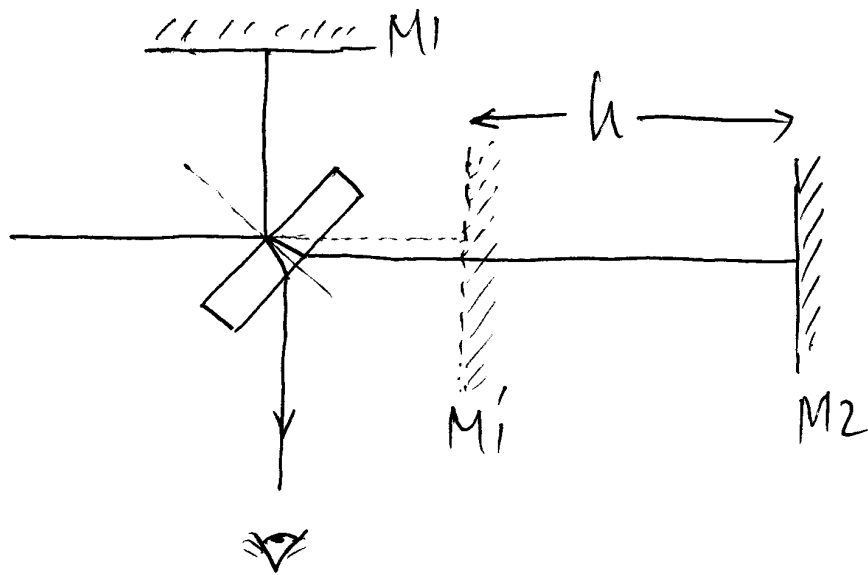

Exactly the same, after reflection or considering the mirror image of M_1 .

Mach-Zehnder interferometer

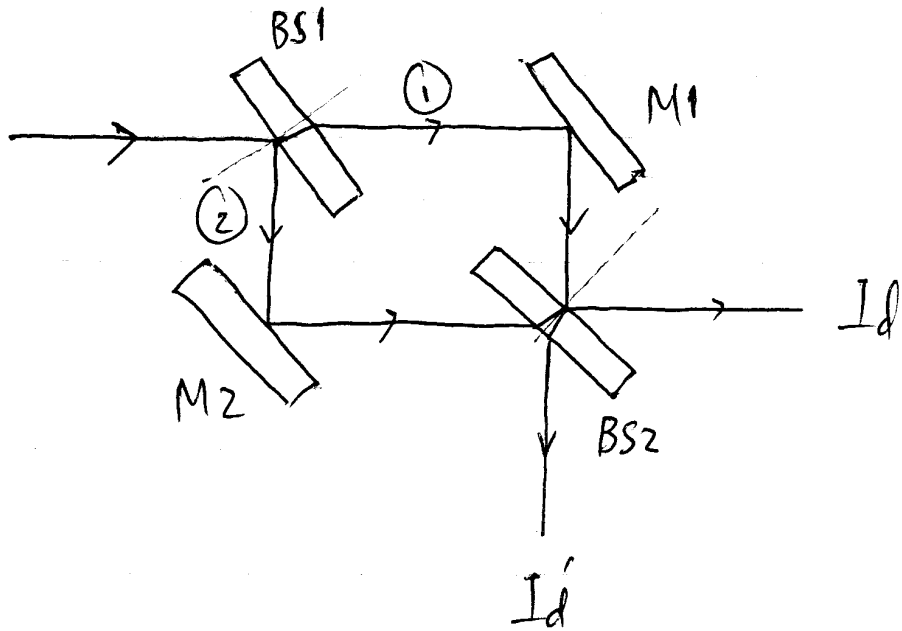

Fiber-based interferometer

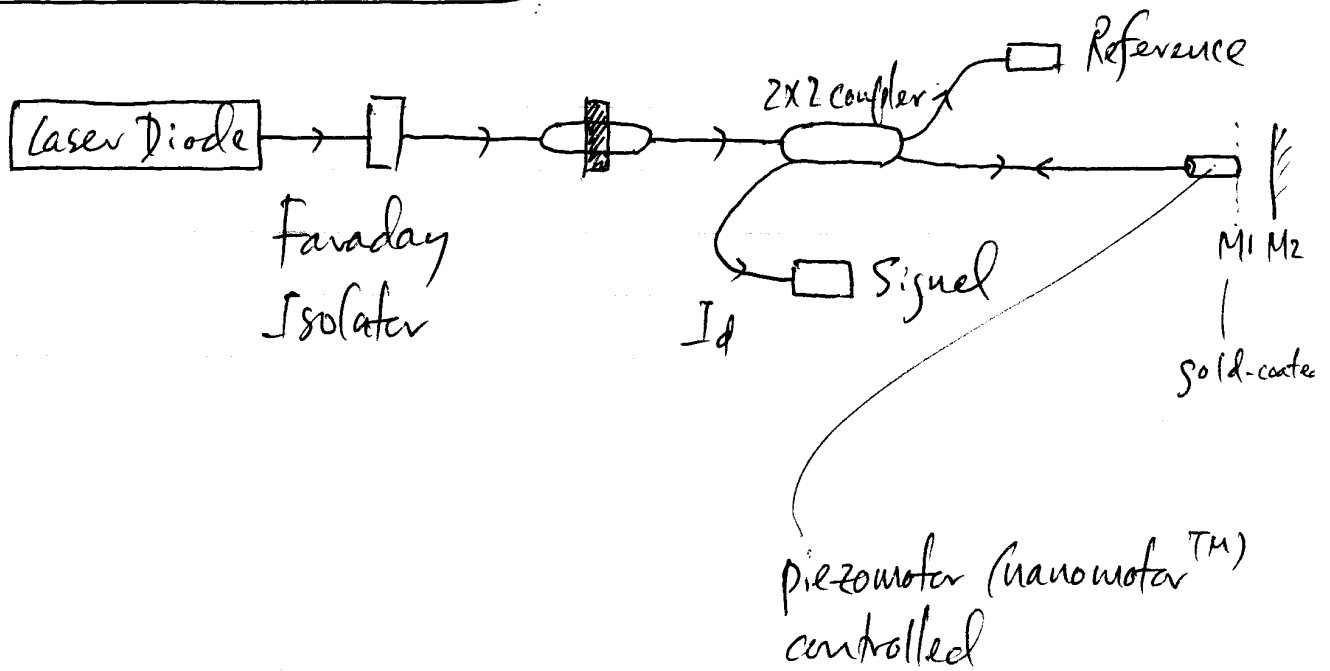

Fourier Transform Optical Spectroscopy (FTIR)

— using Michelson interferometer

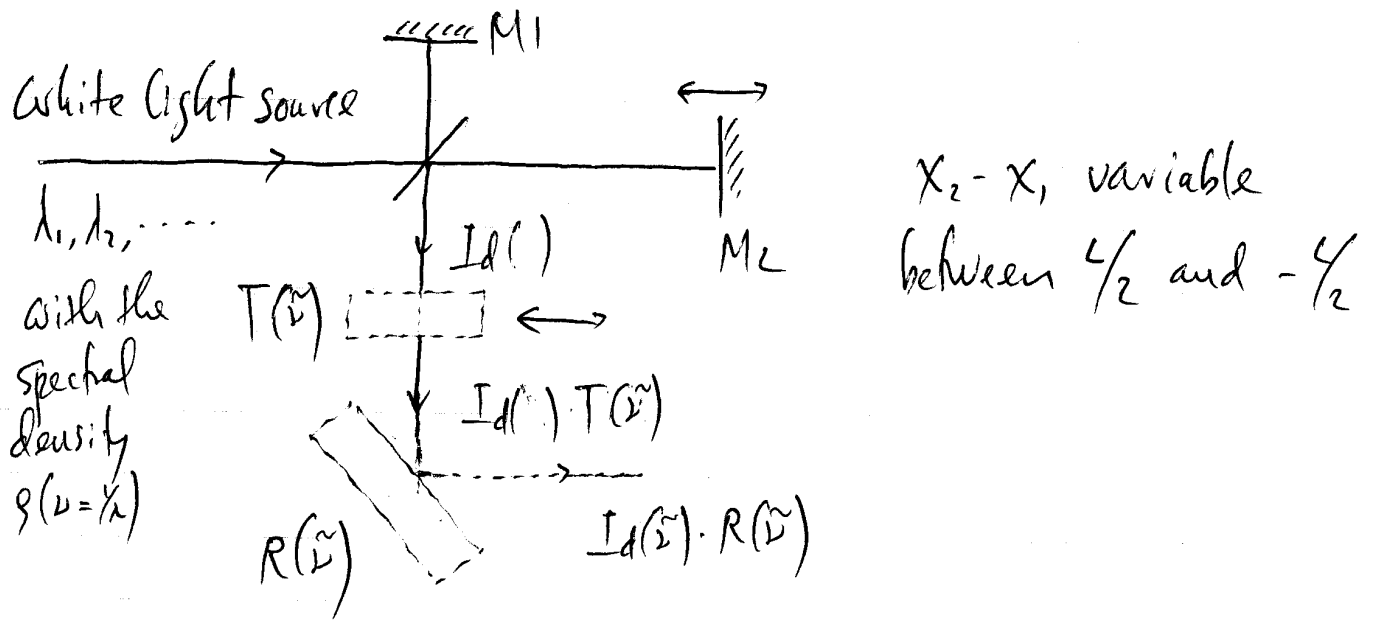

Without either $S(x)$ or $R(\lambda)$, let $z \equiv z(x_2 - x_1)$ so that z varies between $-L$ and $+L$. Let $\tilde{\nu} = 1/\lambda$.

$$I_d(\tilde{\nu}, z) d\tilde{\nu} = g(\tilde{\nu}) d\tilde{\nu} \frac{1}{z} \cdot (1 - \cos(2\pi\tilde{\nu} \cdot z))$$

$$I_d(z) = \int_0^{+\infty} I_d(\tilde{\nu}, z) d\tilde{\nu} = \frac{1}{z} \int_0^{+\infty} g(\tilde{\nu}) d\tilde{\nu} (1 - \cos(2\pi\tilde{\nu} \cdot z))$$

Numerically, in the computer,

$$S_o(\tilde{\nu}') = \int_{-L}^L I_d(z) dz \cos 2\pi\tilde{\nu}'z = c' \int_0^{+\infty} g(\tilde{\nu}) d\tilde{\nu} g(\tilde{\nu}' - \tilde{\nu}) = c' g(\tilde{\nu}')$$

Inserting the sample in transmission mode ($T(\tilde{\nu})$), and measuring again,

$$I_d^{(T)}(z) = \int_0^{\infty} I_d(\tilde{\nu}, z) \cdot T(\tilde{\nu}) d\tilde{\nu}$$

$$S(\tilde{\nu}') = \int_{-L}^L I_d^{(T)}(z) dz a_1 z \pi \tilde{\nu}' z = c' S(\tilde{\nu}') T(\tilde{\nu}')$$

$$T(\tilde{\nu}') = \frac{S(\tilde{\nu}')}{S_0(\tilde{\nu}')}.$$

Inserting the sample in reflection mode, $R(\tilde{\nu})$, and measuring again,

$$I_d^{(R)}(z) = \int_0^{\infty} I_d(\tilde{\nu}, z) R(\tilde{\nu}) d\tilde{\nu}$$

$$S'(\tilde{\nu}') = \int_{-L}^L dz I_d^{(R)}(z) a_1 z \pi \tilde{\nu}' z = c' S'(\tilde{\nu}') R(\tilde{\nu}')$$

$$R(\tilde{\nu}') = \frac{S'(\tilde{\nu}')}{S_0(\tilde{\nu}')}.$$

Fabry-Perot Interferometer:

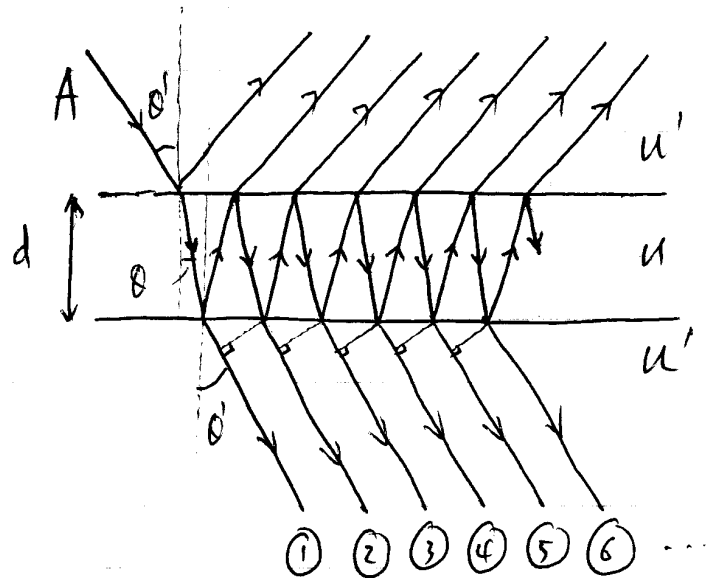
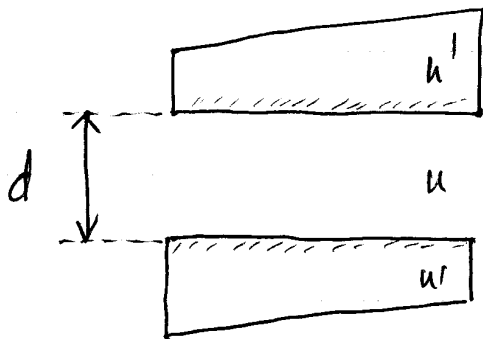

Viewing at the "infinity" with an eye or with a converging lens of the transmitted rays,

$$\begin{aligned}
 E_t &= E_t^{(1)} + E_t^{(2)} + E_t^{(3)} + \dots \\
 &= A t_{12} t_{21} + A t_{12} t_{21} r_{21}^2 e^{i\Delta\phi} + A t_{12} t_{21} r_{21}^4 e^{i2\Delta\phi} + \dots \\
 &= A t_{12} t_{21} \left(1 + r_{21}^2 e^{i\Delta\phi} + (r_{21}^2 e^{i\Delta\phi})^2 + (r_{21}^2 e^{i\Delta\phi})^3 + \dots \right)
 \end{aligned}$$

$$E_t = \frac{A t_{12} \cdot t_{21}}{1 - r_{21}^2 e^{i\Delta\phi}}$$

$$\Delta\phi = \frac{4\pi d}{\lambda_0} n \cos\theta$$

From Stokes' relations, $t_{12}t_{21} + r_{21}^2 = 1$,

$$\tilde{E}_t = A \cdot \frac{1 - r_{21}^2}{1 - r_{21}^2 e^{i\Delta\phi}}$$

$$|\tilde{E}_t|^2 = |A|^2 \cdot \left| \frac{1 - r_{21}^2}{1 - r_{21}^2 e^{i\Delta\phi}} \right|^2$$

$$I_{inc} = \frac{u'}{2\mu_0 c} |A|^2$$

$$I_T = \frac{u'}{2\mu_0 c} |\tilde{E}_t|^2 = I_{inc} \cdot \left| \frac{1 - r_{21}^2}{1 - r_{21}^2 e^{i\Delta\phi}} \right|^2$$

Transmittance

$$T \equiv \frac{I_T}{I_{inc}} = \left| \frac{1 - r_{21}^2}{1 - r_{21}^2 e^{i\Delta\phi}} \right|^2$$

$$\begin{aligned} \left| \frac{1 - r_{21}^2}{1 - r_{21}^2 e^{i\Delta\phi}} \right|^2 &= \frac{(1 - r_{21}^2)^2}{1 + r_{21}^4 - 2r_{21}^2 \cos\Delta\phi} = \frac{(1 - r_{21}^2)^2}{(1 - r_{21}^2)^2 + 2r_{21}^2(1 - \cos\Delta\phi)} \\ &= \frac{1}{1 + \frac{4r_{21}^2 \sin^2 \Delta\phi / 2}{(1 - r_{21}^2)^2}} = \frac{1}{1 + f^2 \sin^2 \Delta\phi / 2} \end{aligned}$$

As a result,

$$T = \frac{1}{1 + f^2 \sin^2(\Delta\phi/2)}, \quad f^2 = \frac{4r_{21}^2}{(1 - r_{21}^2)^2}$$

when $r_{21}^2 = R \cong 1$, highly reflective, $f^2 \gg 1$, then T is non-zero only when

$$\Delta\phi/2 = \frac{2\pi}{\lambda_0} d \cos\theta = m\pi$$

with a very narrow spectral window ($\Delta\tilde{\nu}$) or very narrow angular window ($\Delta\theta$).

By energy conservation,

$$R = 1 - T = \frac{f^2 \sin^2(\Delta\phi/2)}{1 + f^2 \sin^2(\Delta\phi/2)}$$

① Angular spread of a transmission Fabry-Perot Spectrometer.

$$I(\lambda, \theta) = \frac{1}{1 + \rho^2 \sin^2 \left[\frac{2\pi}{\lambda} n d \cos \theta \right]}$$

Assume that at $\theta_0^{(m)}$,

Angle-spacing
 \Rightarrow between neighboring
 transmission maxima.

$$\frac{2\pi}{\lambda_0} n d \cos \theta_0^{(m)} = 2m\pi / 2 = m\pi, \Rightarrow \boxed{\Delta\theta_m = \frac{\lambda}{2nd \sin \theta_0^{(m)}}}$$

then $I(\lambda, \theta_0^{(m)}) = 1$. When θ deviates from $\theta_0^{(m)}$ by a small amount,

$$\frac{2\pi}{\lambda} n d \cos \theta = \frac{2\pi}{\lambda} n d \cos \theta_0^{(m)} - \frac{2\pi}{\lambda} n d \sin \theta_0^{(m)} \delta\theta^{(m)}$$

The angular spread of a FP at λ is defined such that $I(\lambda, \theta_0^{(m)} + \delta\theta^{(m)}) = 1/2$:

$$\left| \rho \sin \left(\frac{2\pi}{\lambda} n d \cos \theta \right) \right| \approx \rho \cdot \frac{2\pi}{\lambda} n d \cdot \sin \theta_0^{(m)} \cdot \delta\theta^{(m)} = 1$$

$$\boxed{\delta\theta_{\lambda_0}^{(m)} = \frac{\lambda_0}{2\pi n d \rho \sin \theta_0^{(m)}}} \Rightarrow \frac{\Delta\theta_m}{\pi \rho} \ll \Delta\theta_m \quad (\because \pi \rho \gg 1)$$

$$\Rightarrow \frac{\Delta\lambda}{\lambda_0} \ll \frac{\Delta\lambda}{\lambda_0}$$

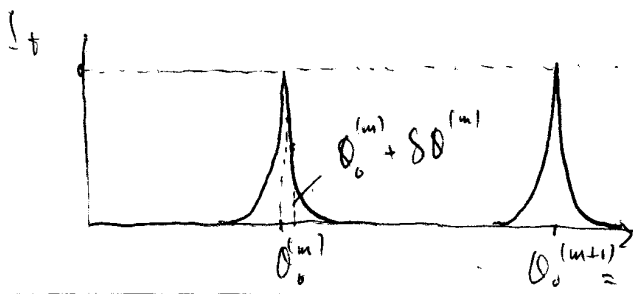

$$\frac{2\pi}{\lambda_0 + \Delta\lambda} n d \cos(\theta_0^{(m)} - \Delta\theta_{\Delta\lambda}^{(m)}) = m\pi$$

$$\frac{2\pi}{\lambda_0} n d \cos \theta_0^{(m)} - \frac{2\pi}{\lambda_0} n d \cos \theta_0^{(m)} \cdot \Delta\lambda + \frac{2\pi}{\lambda_0} n d \sin \theta_0^{(m)} \cdot \Delta\theta_{\Delta\lambda}^{(m)}$$

② Spectral resolution, $(\delta\lambda/\lambda^2$ or $\delta\lambda/\lambda)$ (Rayleigh Criterion)

Assume that at $\theta_0^{(m)}$, λ_0 satisfies

$$\frac{2\pi}{\lambda_0} nd \cos \theta_0^{(m)} = m\pi, \quad I(\lambda_0, \theta_0^{(m)}) = 1.$$

then when λ deviates from λ_0 , the maximum angle deviates from $\theta_0^{(m)}$ accordingly. This is determined by

$$\frac{2\pi}{\lambda_0} nd \cos \theta_0^{(m)} = \frac{2\pi}{\lambda_0 + \delta\lambda} nd \cos[\theta_0^{(m)} + \delta\theta]$$

$$\Rightarrow \boxed{\frac{\delta\lambda}{\lambda_0^2} = \frac{1}{\lambda_0} \frac{\sin \theta_0^{(m)}}{\cos \theta_0^{(m)}} \cdot \delta\theta}$$

The spectral resolution is defined by requiring the maximum for $\lambda_0 + \delta\lambda$ to be no less than $\delta\theta^{(m)}$:

$$\boxed{\frac{\delta\lambda}{\lambda_0^2} = \frac{\sin \theta_0^{(m)}}{\lambda_0 \cos \theta_0^{(m)}} \delta\theta^{(m)} = \frac{1}{2\pi nd \sin \theta_0^{(m)}}}$$

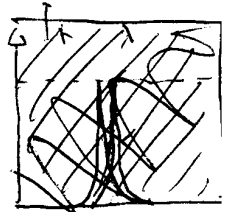

$$\boxed{\frac{\delta\lambda}{\lambda_0} = \frac{\delta\tilde{\nu}}{\tilde{\nu}} = \frac{\lambda_0}{2\pi nd \sin \theta_0^{(m)}} = \frac{1}{mN}}$$

$$N \equiv \pi g_{12} \approx 60 \quad (v_{12}^2 = 0.9)$$

$$d = 1 \text{ mm} = 0.1 \text{ cm}$$

$$\lambda_0 = 6.3 \times 10^{-5} \text{ cm}$$

$$n = 1.5, \quad v_{12}^2 = 0.9$$

$$\theta_0^{(m)} \approx 0, \quad m = 20$$

$$\Rightarrow \frac{\delta\lambda}{\lambda_0} = 3 \times 10^{-6}$$

$$\Rightarrow \frac{\delta\lambda}{\lambda_0} \approx 2.5 \times 10^{-5} = \frac{1}{4000}$$

$$\frac{\delta\lambda}{\lambda} = 10^{-3}$$

$N_a \gg \text{lines}$



H, D
lines

Diffraction theory (including geometric optics)

* Christiaan Huygens (Traite de la lumiere, 1678)

* Augustin Fresnel (1819 Grand Prix Prize for diffraction theory)

Fraunhofer (1823, diffraction theory)

Airy (1835, diffraction from a circular aperture)

Maxwell (1864 and 1873, Maxwell's equations)

Gustav Kirchhoff (1851 -, Kirchhoff Integral from Maxwell's equations)

Huygens-Fresnel Principle

The wave-front of a propagating light wave at any instant conforms to the envelope of spherical wavelets ~~emanating~~ emanating from every point on the wavefront at a prior instant.

The amplitude of the wavefront at any given point equals the superposition of the amplitudes of all the secondary spherical wavelets at that point.

Cross over from geometric optics to diffraction optics

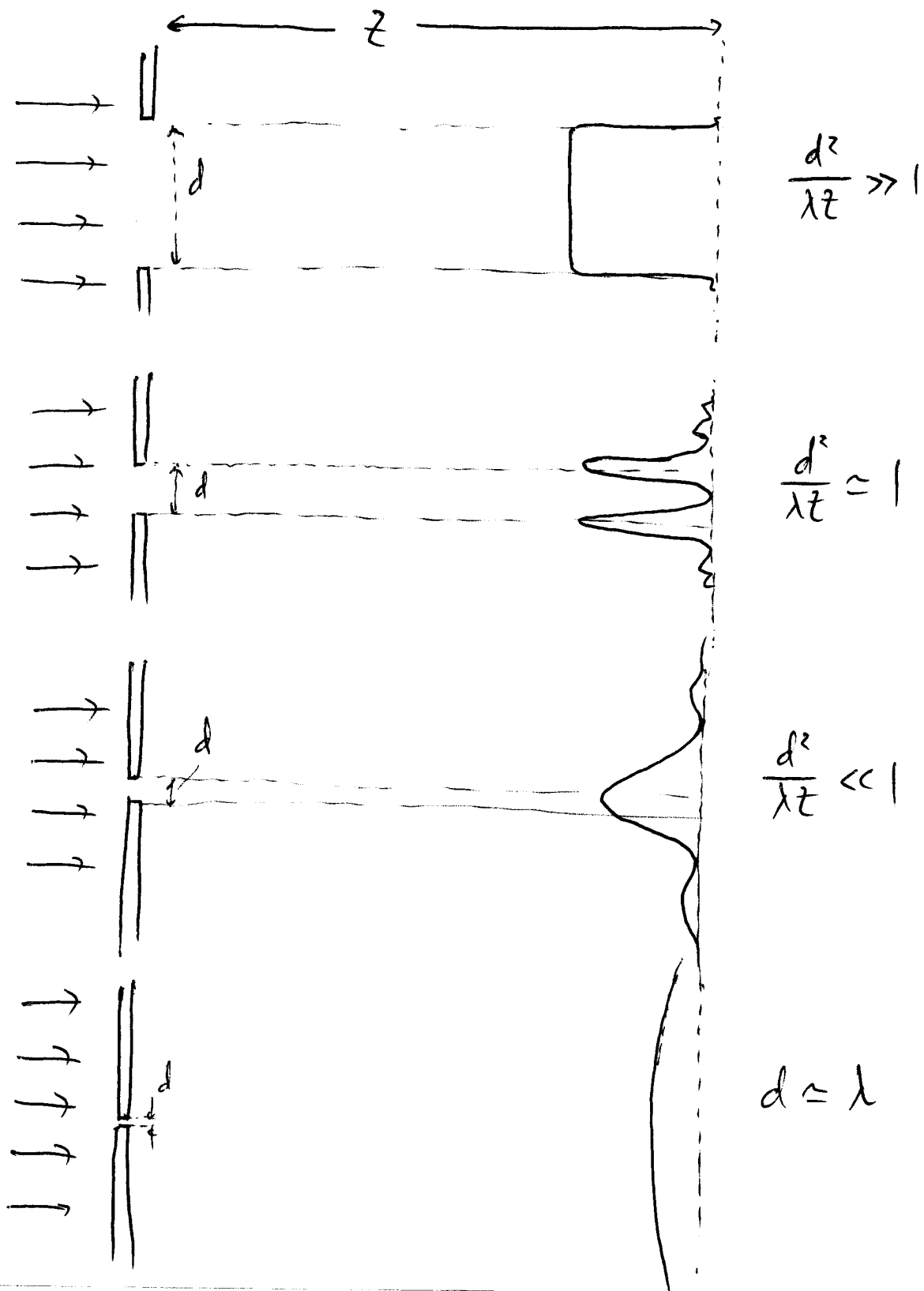

Mathematical result of Huygen's principle:

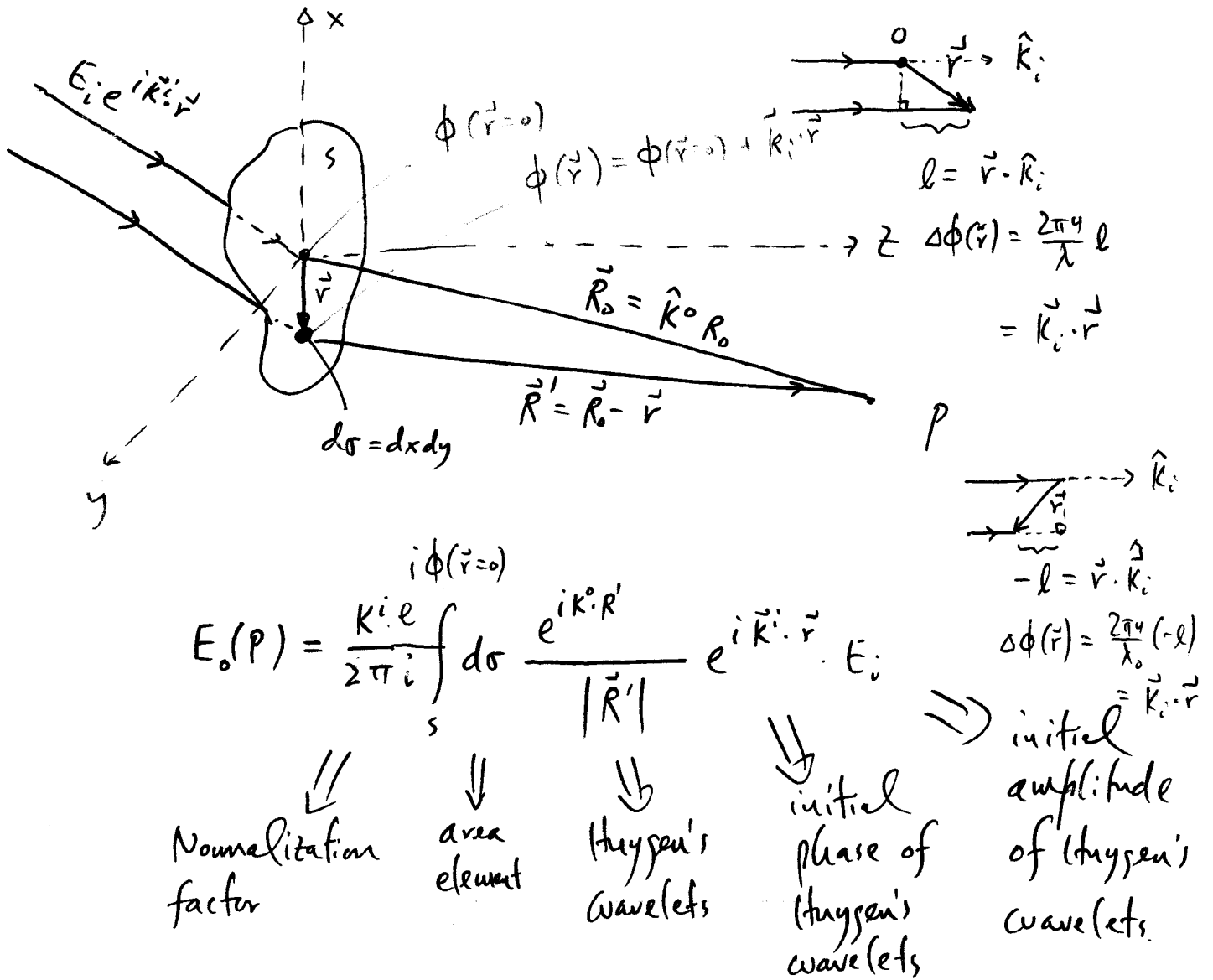

Including a transmission function $T(\vec{r})$:

$$E_0(P) = \frac{k_i}{2\pi i} \int_S d\sigma \frac{e^{i\vec{k}_i \cdot \vec{r}'}}{R'} e^{i\vec{k}_i \cdot \vec{r}} T(\vec{r}) E_i \cdot e^{i\phi(\vec{r}=0)}$$

Single long slit

(Geometric limit along x-direction)

$$\phi(\vec{r}) = \frac{2\sigma}{\lambda} \sqrt{z_0^2 + (y-y_0)^2 + (x-x_0)^2}$$

$$\cong \frac{2\sigma}{\lambda} \sqrt{z_0^2 + (y-y_0)^2} + \frac{2\sigma}{\lambda} \cdot \frac{(x-x_0)^2}{2 \sqrt{z_0^2 + (y-y_0)^2}}$$

$$E(R = \sqrt{z_0^2 + y_0^2}) = \frac{E_{inc} e^{-i\pi/2}}{\lambda} \int_{-d/2}^{d/2} dy \frac{e^{i\vec{k}_{inc} \cdot \vec{r}} \cdot e^{ik \sqrt{z_0^2 + (y-y_0)^2}}}{\sqrt{z_0^2 + (y-y_0)^2}}$$

$$\cdot \int_{-\infty}^{+\infty} dx e^{i \left(\frac{2\sigma}{\lambda} \right) \cdot \frac{(x-x_0)^2}{\sqrt{z_0^2 + (y-y_0)^2}}}$$

$$= \frac{E_{inc} e^{-i\pi/4}}{\sqrt{\lambda}} \int_{-d/2}^{d/2} dy \cdot \frac{e^{ik_{inc,y} y} \cdot e^{ik \sqrt{z_0^2 + (y-y_0)^2}}}{(z_0^2 + (y-y_0)^2)^{1/4}}$$

$$= \frac{E_{inc} e^{-i\pi/4}}{\sqrt{\lambda}} \int_{-d/2}^{d/2} dy \cdot \frac{e^{ik \sqrt{z_0^2 + (y-y_0)^2}}}{(z_0^2 + (y-y_0)^2)^{1/4}} e^{ik_{inc,y} y}$$

cylindrical wavelet.

Normally illuminated long slit

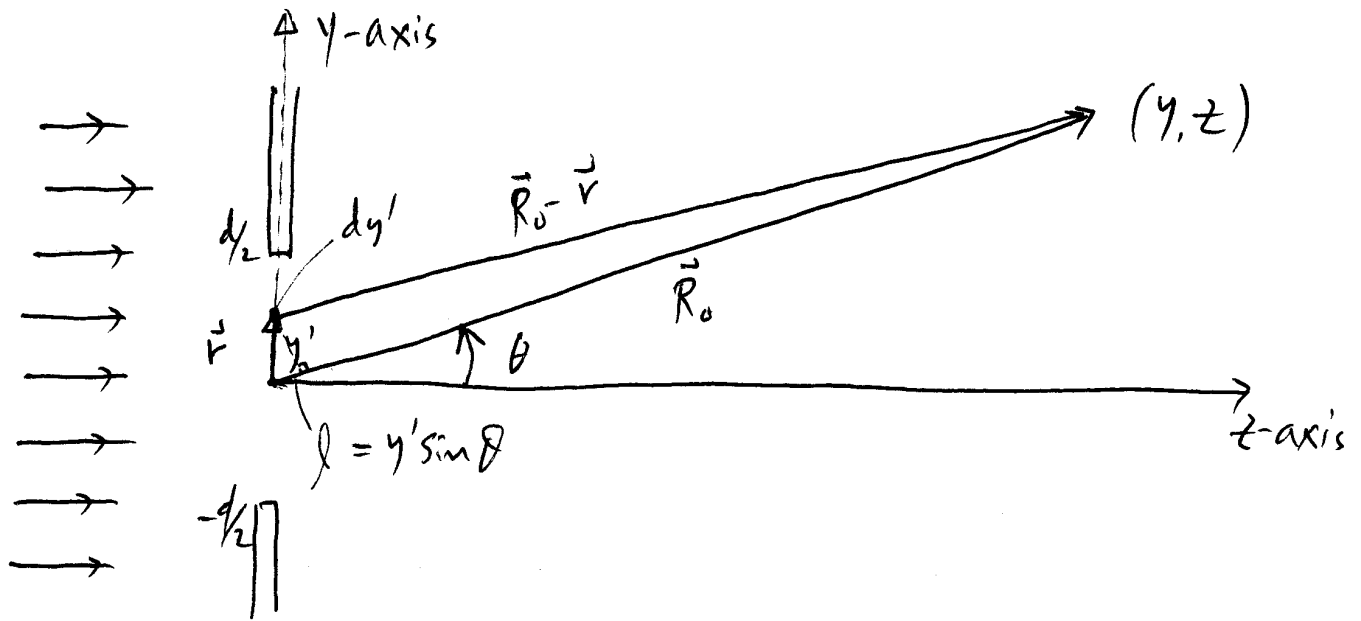

$$E(\vec{R}_0) = \frac{E_{inc}}{\sqrt{\lambda R_0}} \int_{-d/2}^{d/2} dy' e^{i \left(\frac{2\pi y}{\lambda} \right) \cdot |\vec{R}_0 - \vec{r}|}$$

$$R_0 \equiv |\vec{R}_0| = \sqrt{z^2 + y^2}$$

$$= \frac{E_{inc}}{\sqrt{\lambda R_0}} \int_{-d/2}^{d/2} dy' e^{i \left(\frac{2\pi y}{\lambda} \right) \sqrt{z^2 + (y - y')^2}}$$

$$\phi(z, y, y') = \frac{2\pi y}{\lambda} \sqrt{z^2 + (y - y')^2}$$

$$= \frac{2\pi y}{\lambda} \sqrt{z^2 + y^2 - 2yy' + y'^2}$$

$$\approx \frac{2\pi y}{\lambda} \sqrt{z^2 + y^2} - \left(\frac{2\pi y}{\lambda} \right) \cdot \frac{y}{\sqrt{z^2 + y^2}} \cdot y' + \left(\frac{2\pi y}{\lambda} \right) \cdot \frac{y'^2}{\sqrt{z^2 + y^2}} \frac{y^2}{z^2 + y^2} +$$

Fresnel diffraction limit

$$\phi(z, y, y') \cong \frac{2\pi y}{\lambda} R_0 - \left(\frac{2\pi y}{\lambda}\right) \sin\theta \cdot y' + \left(\frac{2\pi y}{\lambda}\right) \sin^2\theta \cdot \frac{y'^2}{R_0}$$

Fraunhofer diffraction limit:

$$\frac{d^2}{\lambda R_0} \ll 1, \quad \left(\frac{2\pi y}{\lambda}\right) \sin^2\theta \frac{y'^2}{R_0} \ll 2\pi$$

$$\phi(z, y, y') \cong \frac{2\pi y}{\lambda} R_0 - \left(\frac{2\pi y}{\lambda}\right) \sin\theta \cdot y' \quad \text{"} \phi(z, y, y'=0) \text{"} \quad \left(\frac{2\pi y}{\lambda}\right) \cdot d$$

$$E(\vec{R}_0) = E(\theta) = \frac{E_{inc}}{\sqrt{\lambda R_0}} e^{i\left(\frac{2\pi y}{\lambda}\right) R_0} \int_{-d/2}^{d/2} dy' e^{-i\left(\frac{2\pi y}{\lambda}\right) \sin\theta \cdot y'}$$

$$= \frac{E_{inc} d}{\sqrt{\lambda R_0}} e^{i\left(\frac{2\pi y}{\lambda}\right) R_0} \cdot \frac{e^{-i\left(\frac{\pi y}{\lambda}\right) d \sin\theta} - e^{i\left(\frac{\pi y}{\lambda}\right) d \sin\theta}}{-i\left(\frac{2\pi y}{\lambda}\right) \sin\theta \cdot d}$$

$$= \frac{E_{inc} d}{\sqrt{\lambda R_0}} e^{i\left(\frac{2\pi y}{\lambda}\right) R_0} \cdot \frac{\sin\left(\frac{\pi d y}{\lambda} \sin\theta\right)}{\left(\frac{\pi d y}{\lambda} \sin\theta\right)}$$

$$I(R_0) = I_{inc} \left(\frac{d^2}{\lambda R_0}\right) \frac{\sin^2\left(\frac{\pi d y}{\lambda} \sin\theta\right)}{\left(\frac{\pi d y}{\lambda} \sin\theta\right)^2}$$

If the slit is obliquely illuminated, at an angle θ_i :

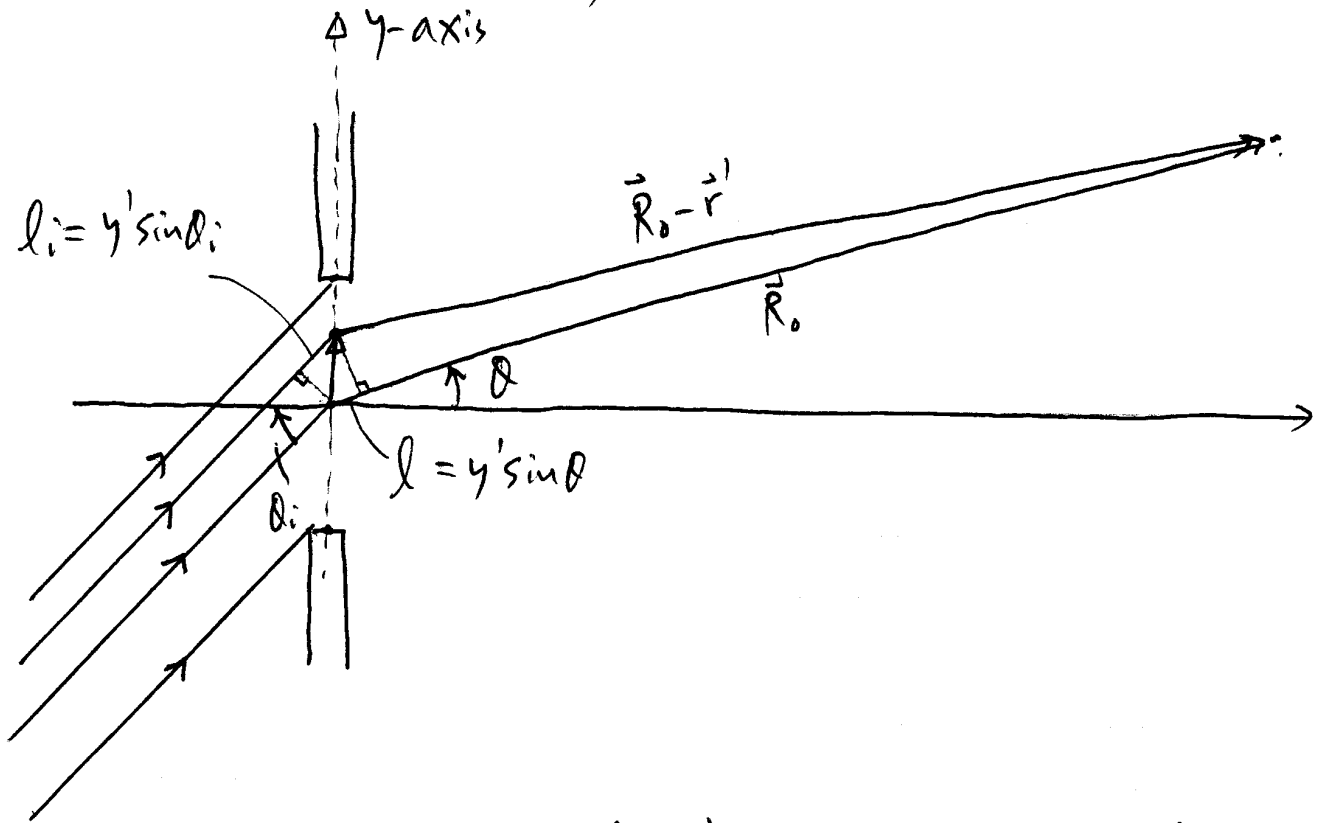

$$\phi_i(\vec{r}') = \phi_i(0) + \left(\frac{2\pi y}{\lambda}\right) l_i = \phi_i(0) + \left(\frac{2\pi y}{\lambda}\right) \sin \theta_i \cdot y'$$

$$\phi(z, y, y') = \phi(z, y, y'=0) - \left(\frac{2\pi y}{\lambda}\right) l = \phi(z, y, 0) - \left(\frac{2\pi y}{\lambda}\right) \sin \theta \cdot y'$$

$$E(\vec{R}_0) = \tilde{t}(\theta) = \frac{E_{inc} e^{i\phi_i(0)}}{\sqrt{\lambda R_0}} \cdot e^{i\left(\frac{2\pi y}{\lambda}\right) R_0} \int_{-d/2}^{d/2} dy' e^{i\left(\frac{2\pi y}{\lambda}\right) (\sin \theta_i - \sin \theta) \cdot y'}$$

$$= \frac{E_{inc} d}{\sqrt{\lambda R_0}} e^{i\phi_i(0) + i\left(\frac{2\pi y}{\lambda}\right) R_0} \frac{\sin\left[\frac{\pi d y}{\lambda} (\sin \theta_i - \sin \theta)\right]}{\frac{\pi d y}{\lambda} (\sin \theta_i - \sin \theta)}$$

Single-slit function:

$$I(\theta_0 = \theta_i) = I_{inc} \frac{d^2}{\lambda R_0}$$

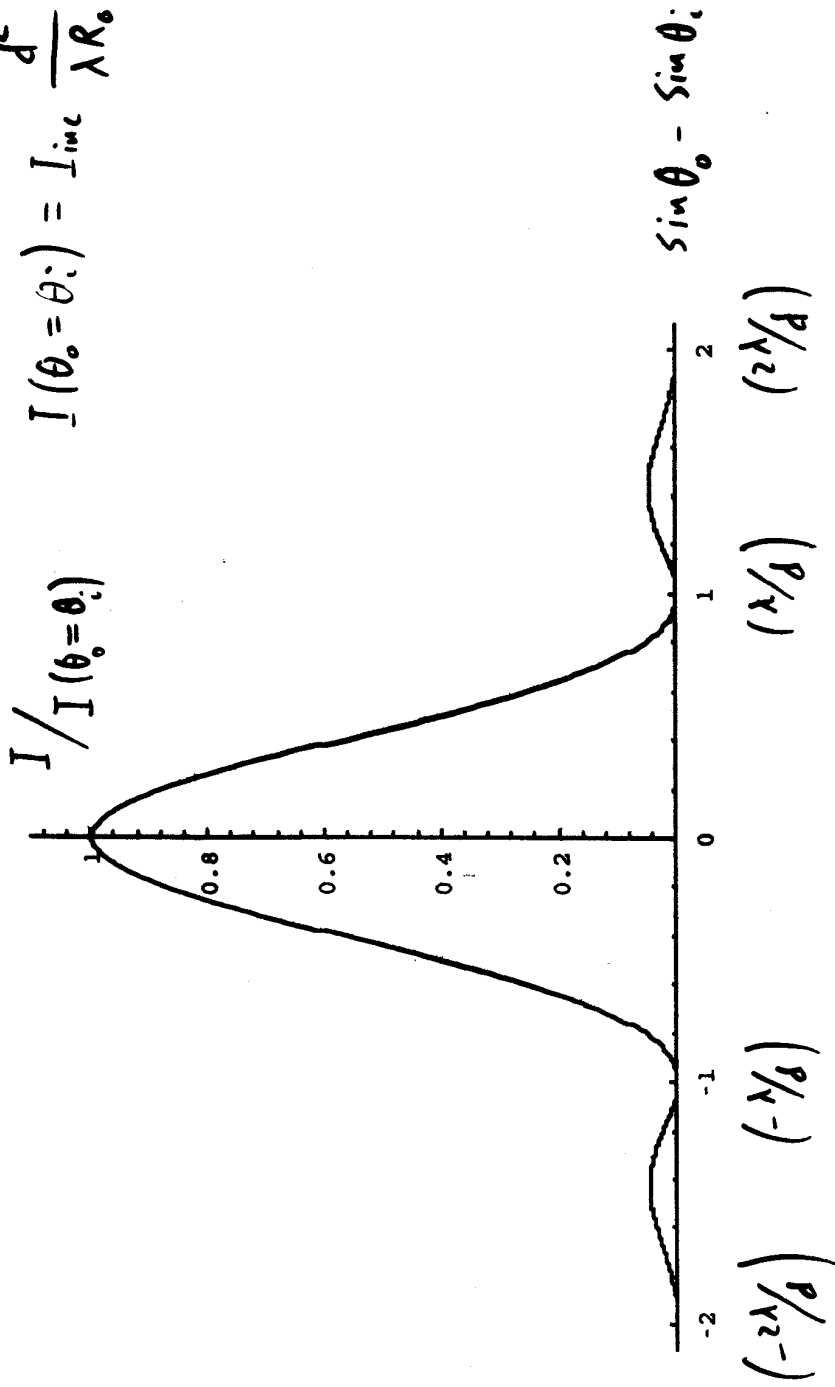

$$\text{Angular spread } \Delta\theta \equiv \frac{\lambda}{d}$$

$$I(\theta) = I_{\max} \frac{2J_1\left(\frac{2\pi}{\lambda_0} a \sin\theta\right)}{\left(\frac{2\pi}{\lambda_0} a \sin\theta\right)}$$

$$\Delta\theta = 2\theta = \frac{2.44\lambda}{d} = \frac{1.22\lambda}{a}$$

$$\theta = \frac{1.22\lambda}{d} \quad (\text{where } J_1(x) = 0 \text{ at } x = 1.22\pi)$$

Examples: (i) Small aperture:

$$\lambda = 6.33 \times 10^{-5} \text{ cm (He-Ne laser)}$$

$$d = 10 \mu\text{m} = 10^{-3} \text{ cm} = 2a$$

$$(2\Delta\theta) = \frac{2\lambda}{d} = 1.3 \times 10^{-1} \text{ rad} = 7.8^\circ$$

$$\therefore \text{At } R_0 = \frac{d}{2\Delta\theta} = \frac{10^{-3} \text{ cm}}{0.13} = 70 \mu\text{m}, \text{ the}$$

transmitted beam will double its linear size.

$$\frac{d}{(2\lambda/d)} = \frac{d^2}{2\lambda}$$

$$R_0 = \frac{d^2}{2\lambda}$$

(ii) large aperture:

$$\lambda = 6.33 \times 10^{-5} \mu\text{m}$$

$$d = 1 \text{ cm}$$

$$\therefore (2\Delta\theta) = \frac{2\lambda}{d} = 1.3 \times 10^{-4} \text{ rad.}$$

$$\therefore \text{At } R_0 = \frac{d}{2\Delta\theta} = 7.7 \times 10^3 \text{ cm} = 77 \text{ meters!}$$

$$\parallel$$

$$2\lambda \approx 10^{-5} \text{ m}$$

$$d = 1 \text{ m}$$

$$R_0 = 1,000 \text{ km}$$

(iii) Divergence of a 0.5 mm diameter He-Ne laser beam.

(Would you think that the beam will stay small-size, collimated?)

$$d = 0.5 \text{ cm}$$

$$2\Delta\theta = \frac{2\lambda}{d} = 2.5 \times 10^{-3} \text{ rad}$$

$$R_0 \text{ double size} = \frac{d}{2\Delta\theta} = 20 \text{ cm!!}$$

To make a collimated beam, you must increase beam size to \leftarrow increase the collimated region!!

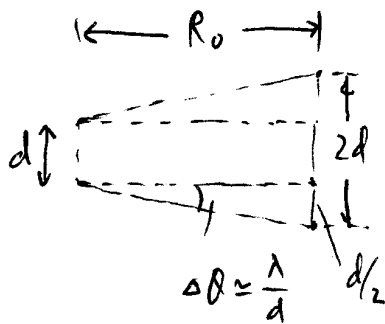

when $\frac{d}{2} = R_0 \Delta\theta$ or

This means that in the near field, the beam profile is the same as at $R_0 = 0$, and we can ignore diffraction effect.

Spatial resolution of a microscope and a telescope.

For a telescope with entrance aperture D and focal length f_0 , the minimum resolved angle separation $\delta\alpha$ will have to be

$$\delta\theta_{1/2} = \frac{\lambda}{D} = \delta\alpha$$

For a 70-m telescope, we have for a visible optical wave $\lambda = 0.5 \mu\text{m}$,

$$\delta\alpha = \frac{\lambda}{D} = 5 \times 10^{-8} \text{ radians}$$

For a microscope with entrance aperture D and focal length f_0 , the linear resolution in the object plane δy_0 is related to its image δy_i in the first image plane at $L = 200\text{mm}$ away. We can think of the microscope objective as a combination of two lenses (perfect lenses) so that the first lens forms the image of an object point at infinity, and the second lens brings the image at the infinity to L away from itself. Now because of the Rayleigh

diffraction, the "collimated" beam becomes a set of "collimated" beam-lets that spread over an angle of

$$\delta\theta_{\frac{1}{2}} = \frac{1.22\lambda}{D}$$

As a result, after the "second" lens, the image of an object point becomes blurred into a disc with a diameter

$$\delta r = \delta\theta_{\frac{1}{2}} \cdot L = \frac{1.22\lambda}{D} L$$

This means that on the image plane, the linear spatial resolution

$$\delta y_i = \delta r = \frac{1.22\lambda}{D} L$$

Now the spatial resolution in the object plane

$$\delta y_o = \delta y_i \left(\frac{s_o}{s_i} \right) = \delta y_i \frac{f_o}{L} = 1.22 \cdot \frac{f_o}{D} \cdot \lambda$$

~~$\delta y_o = \delta y_i \left(\frac{s_o}{s_i} \right) = \delta y_i \frac{f_o}{L} = 1.22 \cdot \frac{f_o}{D} \cdot \lambda$~~

$$\therefore \delta y_o = (1.22\lambda) \cdot \frac{f}{D}$$

N.A. = numerical aperture
 $= n \sin \theta$

Single long reflecting strip

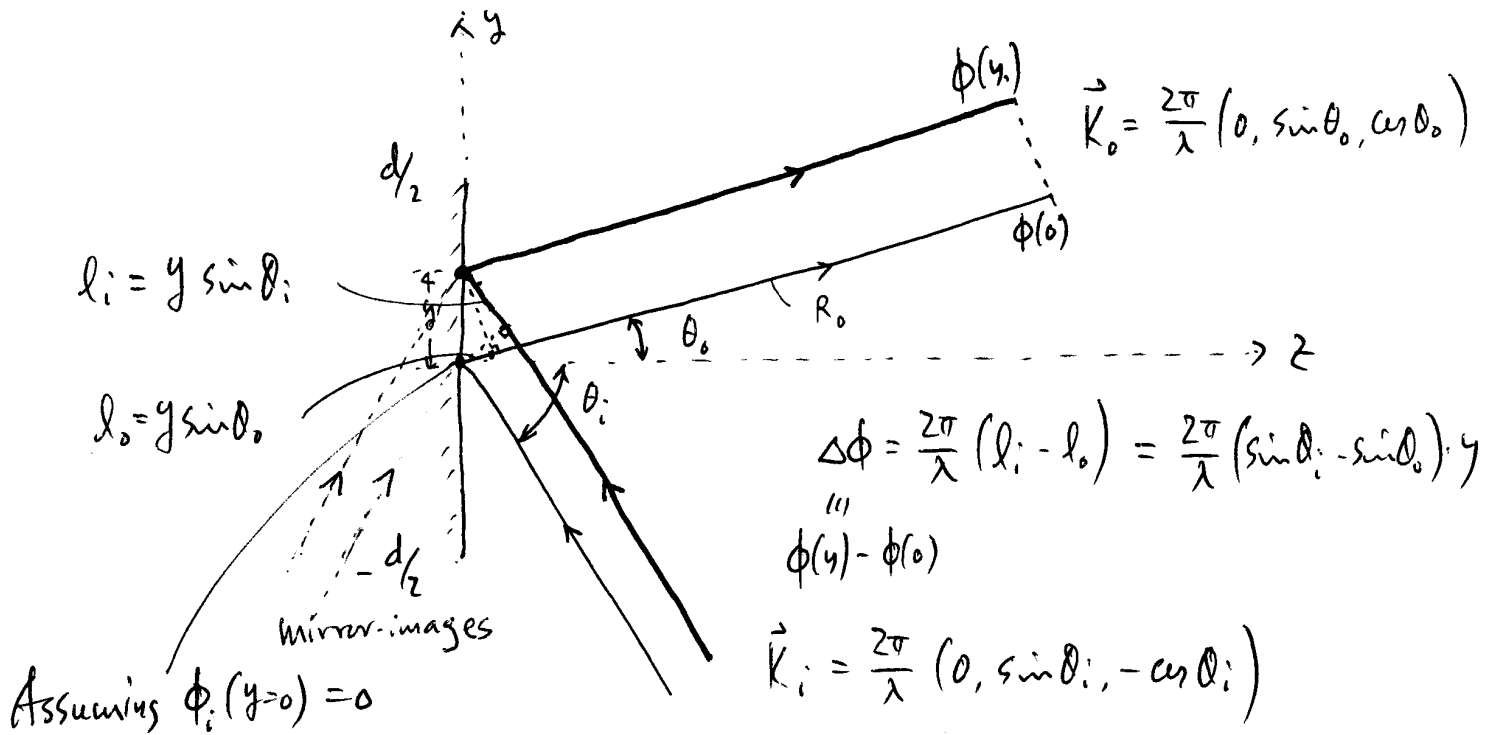

$$E_v(\vec{k}_0) = E_{inc} \frac{e^{i k_0 R_0 + i \phi_i(0)}}{\sqrt{\lambda R_0}} \cdot d \cdot \frac{\sin \left[\frac{\pi}{\lambda} d (\sin \theta_i - \sin \theta_0) \right]}{\frac{\pi}{\lambda} d (\sin \theta_i - \sin \theta_0)} \cdot \gamma$$

$$I_v(\vec{k}_0) = I_v(\theta_0) = I_{inc} |\gamma|^2 \frac{d^2}{\lambda R_0} \frac{\sin^2 \left[\frac{\pi}{\lambda} d (\sin \theta_i - \sin \theta_0) \right]}{\left[\frac{\pi}{\lambda} d (\sin \theta_i - \sin \theta_0) \right]^2}$$

The diffraction is maximized at

$$\theta_0 = \theta_i \quad (\text{reflection law})$$

with respect to the surface normal of the surface!!!

$$\phi_i^{(n)} - \phi_i^{(n-1)} = (n-1) (\phi_i^{(2)} - \phi_i^{(1)}) = (n-1) \frac{2\pi u}{\lambda} l_i$$

$$\frac{2\pi u}{\lambda} (R_o^{(n)} - R_o^{(1)}) = (n-1) \frac{2\pi u}{\lambda} (R_o^{(2)} - R_o^{(1)}) = (n-1) \frac{2\pi u}{\lambda} l_o$$

Multiple long reflection strips

reflection grating

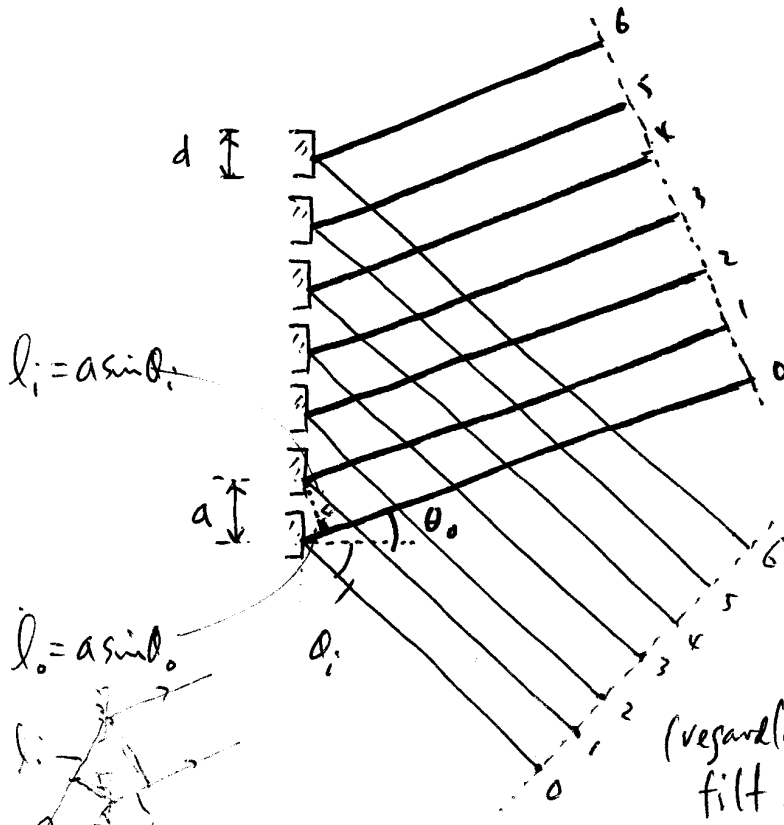

Referenced to Ray #0,
each successive ray
has an additional
phase

$$\Delta\phi = \frac{2\pi}{\lambda} a (\sin \theta_i - \sin \theta_0)$$

$$\Delta\phi^{(u)} = \phi^{(u)} - \phi^{(0)}$$

$$= \frac{2\pi}{\lambda} a u (\sin \theta_i - \sin \theta_0)$$

$$E(\theta_0) = \sum_{n=0}^{N-1} E^{(n)}(\theta_0) = \sum_{u=0}^{N-1} \frac{\gamma \cdot E_{inc} \cdot d \cdot \sin(\dots)}{\sqrt{\lambda R_o^{(u)}}} \cdot e^{i\phi^{(u)}}$$

$$\approx \frac{\gamma \cdot E_{inc} \cdot d}{\sqrt{\lambda R_o^{(0)}}} e^{i\phi^{(0)}} \cdot \frac{\sin\left(\frac{\pi}{\lambda} d (\sin \theta_i - \sin \theta_0)\right)}{\frac{\pi}{\lambda} d (\sin \theta_i - \sin \theta_0)} \cdot \sum_{u=0}^{N-1} e^{i\Delta\phi^{(u)}}$$

$$\sum_{u=0}^{N-1} e^{i\Delta\phi^{(u)}} = \sum_{u=0}^{N-1} \left(e^{i \frac{2\pi}{\lambda} a (\sin \theta_i - \sin \theta_0)} \right)^u = e^{i \frac{N-1}{2} \Delta\phi} \cdot \frac{\sin\left(\frac{N}{2} \Delta\phi\right)}{\sin(\Delta\phi/2)}$$

$$\therefore I(\theta_0) = I_{inc} |v|^2 \cdot \frac{N^2 d^2}{\lambda R_0} \cdot (\text{single-slit function}) (\text{multiple-slit func.})$$

$$\text{Single-slit function} \equiv \frac{\sin^2\left(\frac{\pi}{\lambda} d (\sin \alpha_i - \sin \alpha_0)\right)}{\left(\frac{\pi}{\lambda} d (\sin \alpha_i - \sin \alpha_0)\right)^2}$$

$$\text{Multiple-slit function} \equiv \frac{\sin^2\left(\frac{\pi}{\lambda} N a (\sin \alpha_i - \sin \alpha_0)\right)}{\left(N \sin\left(\frac{\pi}{\lambda} a (\sin \alpha_i - \sin \alpha_0)\right)\right)^2}$$

$$I(\theta_0) = I_{\text{single, max}} N^2 \cdot (\text{single-slit funct.}) (\text{multiple-slit})$$

Multiple-slit function has infinite maxima when

$$\frac{\pi}{\lambda} a (\sin \alpha_i - \sin \alpha_0) = m\pi, \quad m = 0, \pm 1, \pm 2,$$

$$\sin \alpha_0 = \sin \alpha_i - m \frac{\lambda}{a}, \quad m = 0, \pm 1, \pm 2,$$

Example: $a = 2d$, $N = 3$ (In general, Mathematica plot)

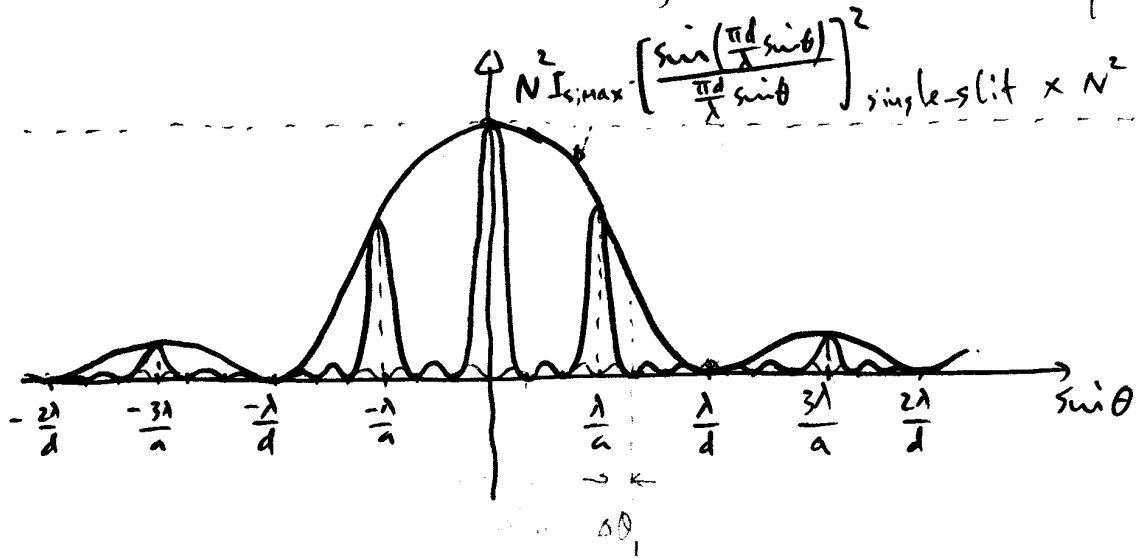

Angular width:

m^{th} - Maxima at $\frac{\pi}{\lambda} a \sin \theta_m = m\pi$, first minimum appears when

$$N \cdot \frac{\pi}{\lambda} a \sin(\theta_m + \Delta \theta_m) = Nm\pi + \pi \Rightarrow \sin\left(N \frac{\pi}{\lambda} a \sin \theta\right) = a$$

$$\therefore \boxed{\Delta \theta_m = \frac{\lambda}{Na \cos \theta}}$$

but
 $N \sin\left(\frac{\pi}{\lambda} a \sin \theta\right) = 0$

Spectral resolution:

Let $\theta_m(\lambda + \Delta \lambda) = \theta_m + \Delta \theta_m$, i.e., λ' peaks at an angle θ' where λ has its first minimum: ($\lambda' = \lambda + \Delta \lambda$)

$$N\pi a \cdot \frac{1}{\lambda + \Delta \lambda} \sin(\theta_m + \Delta \theta_m) = Nm\pi$$

$$\therefore \frac{\Delta \lambda}{\lambda} \sin \theta_m = \cos \theta_m \Delta \theta_m \Rightarrow \boxed{\frac{\Delta \lambda}{\lambda} = \frac{\lambda}{Na \sin \theta_m} = \frac{1}{Nm}}$$

(Rayleigh-Resol.)

Blazed reflection grating

Shifting the maximum of the single-slit function to the first-order diffraction ($m = \pm 1$) angles of the multiple slit function:

\Rightarrow improve the grating efficiency

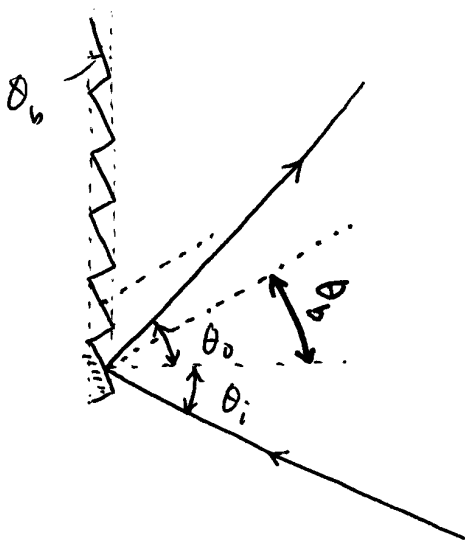

For single slit function,
the real incidence angle

$$\theta_i' = \theta_i + \theta_b;$$

the real reflection angle

$$\theta_o' = \theta_o - \theta_b$$

$$\therefore I(\theta_o) = I_{\text{single, max}} \cdot \frac{\sin^2 \left[\frac{\pi}{\lambda} d (\sin(\theta_o - \theta_b) - \sin(\theta_i + \theta_b)) \right]}{\left[\frac{\pi}{\lambda} d (\sin(\theta_o - \theta_b) - \sin(\theta_i + \theta_b)) \right]^2} \cdot (\text{mult. ple})$$

New single slit function peaks at $\theta_o = \theta_i + 2\theta_b$.
Multiple-slit first-order diffraction peaks at

$$\begin{cases} \sin \theta_o = \sin \theta_i + \frac{\lambda}{a} & (\text{multiple slit}) \\ \theta_o = \theta_i + 2\theta_b & (\text{single slit}) \end{cases}$$

Relationship between \vec{k} , ϵ , \vec{E} and \vec{B}

$$\text{From } \nabla^2 \vec{E} = \epsilon \epsilon_0 \mu_0 \frac{d^2}{dt^2} \vec{E}$$

$$- \vec{k} \cdot \vec{k} = - \epsilon \epsilon_0 \mu_0 \omega^2$$

$$\therefore \vec{k} \cdot \vec{k} = (k)^2 = \epsilon \frac{\omega^2}{c^2}$$

$$\therefore k = \sqrt{\epsilon} \frac{\omega}{c} = n \frac{\omega}{c} = n \frac{2\pi}{\lambda_0} = \frac{2\pi}{\lambda}$$

$$\vec{k} = \hat{k} n \frac{\omega}{c} = \hat{k} \cdot n \cdot \frac{2\pi}{\lambda_0}$$

$$\text{From } \nabla \times \vec{E} = - \frac{d}{dt} \vec{B}$$

$$\nabla \times \vec{E} = - \vec{k} \times \vec{E} \sin(\vec{k} \cdot \vec{r} - \omega t)$$

$$- \frac{d}{dt} \vec{B} = - \omega \vec{B} \sin(\vec{k} \cdot \vec{r} - \omega t)$$

$$\vec{B} = \frac{\vec{k}}{\omega} \times \vec{E} = \frac{n}{c} \hat{k} \times \vec{E}$$

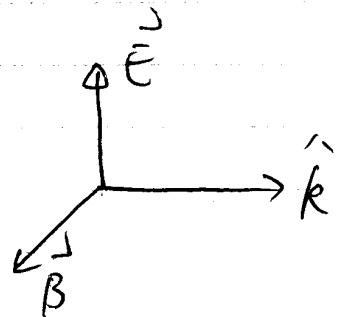

Transversality relations:

$$\nabla \cdot \vec{E} = 0$$

$$\Rightarrow$$

$$\vec{k} \cdot \vec{E} = 0$$

$$\nabla \cdot \vec{B} = 0$$

$$\Rightarrow$$

$$\vec{k} \cdot \vec{B} = 0$$

Reflection and transmission of a plane-wave e.m. field at a flat interface between two dielectric materials ($\epsilon_1 = n_1^2$ and $\epsilon_2 = n_2^2$)

$$\vec{E}(\vec{r}, t) = \vec{E} \cos(\vec{k} \cdot \vec{r} - \omega t)$$

$$\vec{B}(\vec{r}, t) = \vec{B} \cos(\vec{k} \cdot \vec{r} - \omega t) = \frac{n}{c} \hat{k} \times \vec{E} \cos(\vec{k} \cdot \vec{r} - \omega t)$$

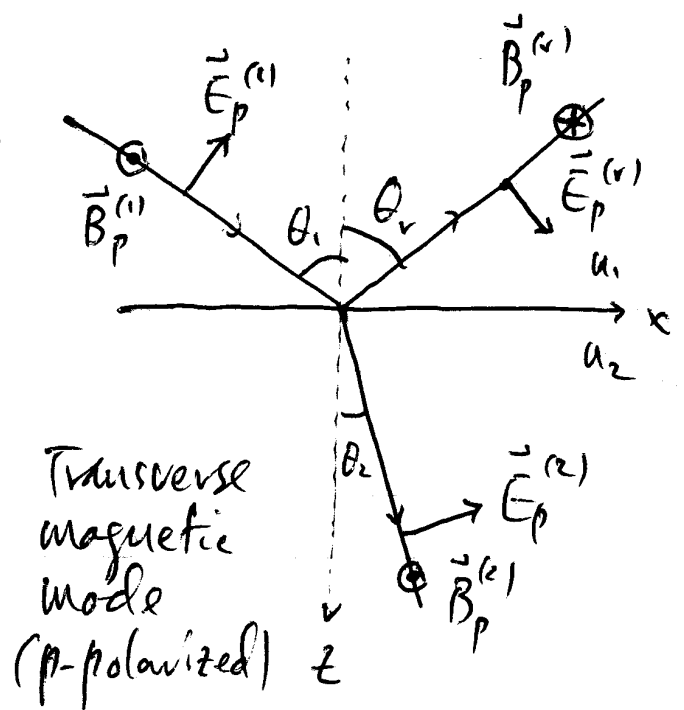
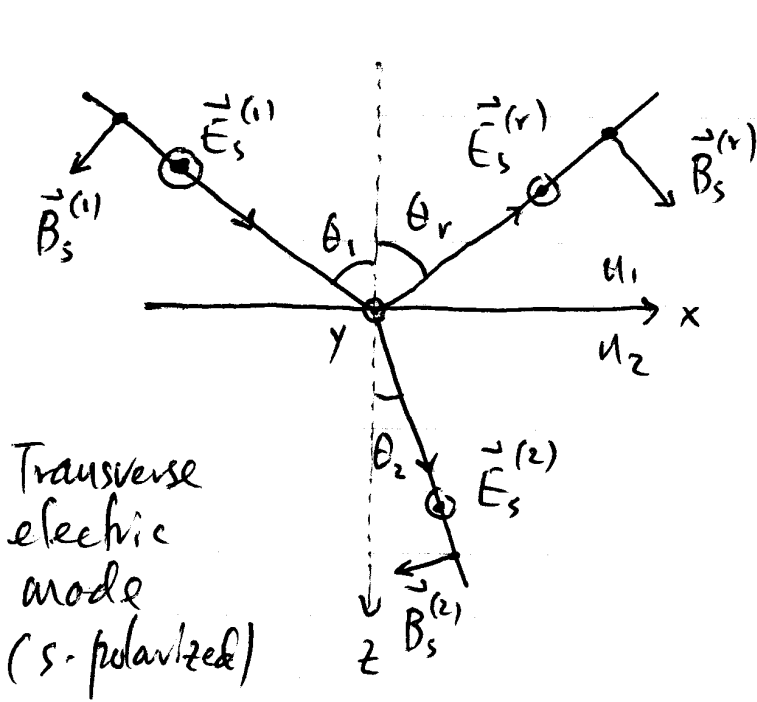

$$\vec{k}^{(i)} = n_1 \left(\frac{\omega}{c} \right) (\sin \theta_i, 0, \cos \theta_i) = n_1 \left(\frac{2\pi}{\lambda} \right) (\sin \theta_i, 0, \cos \theta_i)$$

$$\vec{k}^{(r)} = n_1 \left(\frac{\omega}{c} \right) (\sin \theta_r, 0, -\cos \theta_r) = n_1 \left(\frac{2\pi}{\lambda} \right) (\sin \theta_r, 0, -\cos \theta_r)$$

$$\vec{k}^{(t)} = n_2 \left(\frac{\omega}{c} \right) (\sin \theta_t, 0, \cos \theta_t) = n_2 \left(\frac{2\pi}{\lambda} \right) (\sin \theta_t, 0, \cos \theta_t)$$

Incidence plane

the flat plane that contains $\vec{k}^{(i)}$ and the surface normal or z -axis

Snell's law of reflection and refraction

From the Maxwell's equations at the boundary, i.e.,

$$\boxed{E_{1t} = E_{2t} \text{ and } B_{1t} = B_{2t}}$$

for s -polarized l.m. wave,

$$\vec{E}_s^{(i)} \cos(k_x^{(i)} \cdot x - \omega t) + \vec{E}_s^{(r)} \cos(k_x^{(r)} \cdot x - \omega t) = \vec{E}_s^{(2)} \cos(k_x^{(2)} \cdot x - \omega t)$$

this can only be satisfied when $k_x^{(i)} = k_x^{(r)} = k_x^{(2)}$,
or

$$\boxed{\theta_r = \theta_i \quad u_1 \sin \theta_1 = u_2 \sin \theta_2}$$

For p -polarized l.m. wave,

$$B_p^{(i)} \cos(k_x^{(i)} \cdot x - \omega t) - B_p^{(r)} \cos(k_x^{(r)} \cdot x - \omega t) = B_p^{(2)} \cos(k_x^{(2)} \cdot x - \omega t)$$

Again, it can be satisfied if $\boxed{k_x^{(2)} = k_x^{(r)} = k_x^{(i)}}$

Reflection and transmission coefficients

— Fresnel equations (verify Stokes' relation)

Transverse electric wave (s-polarized components)

$$E_s^{(1)} + E_s^{(r)} = E_s^{(2)} \quad \dots \quad (1)$$

$$-n_1 \cos \theta_1 E_s^{(1)} + n_1 \cos \theta_1 E_s^{(r)} = -n_2 \cos \theta_2 E_s^{(2)} \quad \dots \quad (2)$$

$$E_s^{(1)} - E_s^{(r)} = \frac{n_2 \cos \theta_2}{n_1 \cos \theta_1} E_s^{(2)} \quad \dots \quad (3)$$

(1) + (3):

$$t_{s,12} \equiv \frac{E_s^{(2)}}{E_s^{(1)}} = \frac{2n_1 \cos \theta_1}{n_1 \cos \theta_1 + n_2 \cos \theta_2}$$

$$r_{s,12} \equiv \frac{E_s^{(r)}}{E_s^{(1)}} = t_{s,12} - 1 = -\frac{n_2 \cos \theta_2 - n_1 \cos \theta_1}{n_2 \cos \theta_2 + n_1 \cos \theta_1}$$

Verify yourself that $r_{s,12} = -r_{s,21}$, $r_{s,12}^2 + t_{s,12}t_{s,21} = 1$

At normal incidence, $\theta_1 = 0$, $\theta_2 = 0$,

$$t_{s,12}(\theta_1=0) = \frac{2n_1}{n_1 + n_2} \quad r_{s,12}(\theta_1=0) = -\frac{n_2 - n_1}{n_2 + n_1}$$

Transverse magnetic wave (p-polarized components)

$$E_p^{(i)} \cos \theta_1 + E_p^{(r)} \cos \theta_1 = E_p^{(t)} \cos \theta_2 \quad \dots \quad (1)$$

$$n_1 E_p^{(i)} - n_1 E_p^{(r)} = n_2 E_p^{(t)} \quad \dots \quad (2)$$

$$\text{From (1):} \quad E_p^{(i)} + E_p^{(r)} = \frac{\cos \theta_2}{\cos \theta_1} E_p^{(t)} \quad \dots \quad (3)$$

$$\text{From (2):} \quad E_p^{(i)} - E_p^{(r)} = \frac{n_2}{n_1} E_p^{(t)} \quad \dots \quad (4)$$

(3) + (4):

$$t_{p,12} \equiv \frac{E_p^{(t)}}{E_p^{(i)}} = \frac{2n_1 \cos \theta_1}{n_1 \cos \theta_2 + n_2 \cos \theta_1}$$

$$r_{p,12} \equiv \frac{E_p^{(r)}}{E_p^{(i)}} = 1 - \frac{n_2}{n_1} t_{p,12} = \frac{n_1 \cos \theta_2 - n_2 \cos \theta_1}{n_1 \cos \theta_2 + n_2 \cos \theta_1}$$

Again, Stokes' relations hold.

At normal incidence, our choices of assumed directions of the electric fields ensure that $t_{p,12} = t_{s,12}$ and $r_{p,12} = r_{s,12}$ as expected.

Directions of reflected and transmitted electric fields relative to incidence electric field.

Transverse electric mode (TE, s-polarization)

$$t_{s,12} = \frac{2n_1 \cos \theta_1}{n_1 \cos \theta_1 + n_2 \cos \theta_2} > 0 \quad \text{as long as } \theta_2 \text{ exists}$$

$$r_{s,12} = - \frac{n_2 \cos \theta_2 - n_1 \cos \theta_1}{n_1 \cos \theta_1 + n_2 \cos \theta_2} < 0, \quad \text{if } n_2 > n_1$$

$$< 0, \quad \text{if } n_2 < n_1$$

(as long as θ_2 exists)

Transverse magnetic mode (TM, p-polarization)

$$t_{p,12} = \frac{2n_1 \cos \theta_1}{n_1 \cos \theta_2 + n_2 \cos \theta_1} > 0, \quad \text{as long as } \theta_2 \text{ exists}$$

$$r_{p,12} = - \frac{n_2 \cos \theta_1 - n_1 \cos \theta_2}{n_2 \cos \theta_1 + n_1 \cos \theta_2} \quad \text{changes sign at } \theta_1 = \theta_B$$

When $n_2 \cos \theta_B = n_1 \cos \theta_2$. This special incidence angle is called Brewster angle, $r_{p,12}(\theta_B) = 0$

4. Brewster angle θ_B :

For p-polarized waves, there is an incidence angle θ_B at which the reflection vanishes in intensity

$$\begin{aligned} r_p &= 0 \\ n_2 \cos \theta_i &= n_1 \cos \theta_t \end{aligned}$$

(only for p-waves)

Now, since Snell's law states $n_1 \sin \theta_i = n_2 \sin \theta_t$, we have

$$\sin 2\theta_i = \sin 2\theta_t$$

As $\theta_i \neq \theta_t$ ($n_1 \neq n_2$), we have

$$2\theta_i = \pi - 2\theta_t$$

$$\therefore \theta_t = \frac{\pi}{2} - \theta_i$$

$$\Rightarrow \tan \theta_i = \frac{n_2}{n_1}$$

$$\theta_i = 56^\circ 40'$$

$$\therefore \omega / \omega_c = 1.52$$

Let $n_1 > n_2$ (glass-to-air)

$$\begin{aligned} t_p(\theta_B) &= \frac{2n_1 \cos \theta_B}{n_1 \cos \theta_B + n_2 \cos \theta_B} \\ &= \frac{2n_1 \cos \theta_B}{n_1 \sin \theta_B + n_2 \cos \theta_B} \\ &= \frac{2n_1}{n_1 \left(\frac{n_2}{n_1}\right) + n_2} = \frac{n_1}{n_2} > 1 \end{aligned}$$

$E_p^{(2)} > E_p^{(1)}$!!

$\vec{E}_p^{(t)}$ (and therefore $\vec{p}_p^{(t)}$) is parallel to the reflection direction, therefore no dipole-radiation is allowed #

Energy conservation in e.m. wave reflection and transmission.

The intensity (energy per unit area per second) of a plane-wave e.m. wave is given by

$$I = |\vec{S}| = \left| \frac{1}{\mu_0} \vec{E} \times \vec{B} \right|^2 = \frac{1}{2\mu_0} \sqrt{\epsilon} \cdot |\vec{E}|^2$$

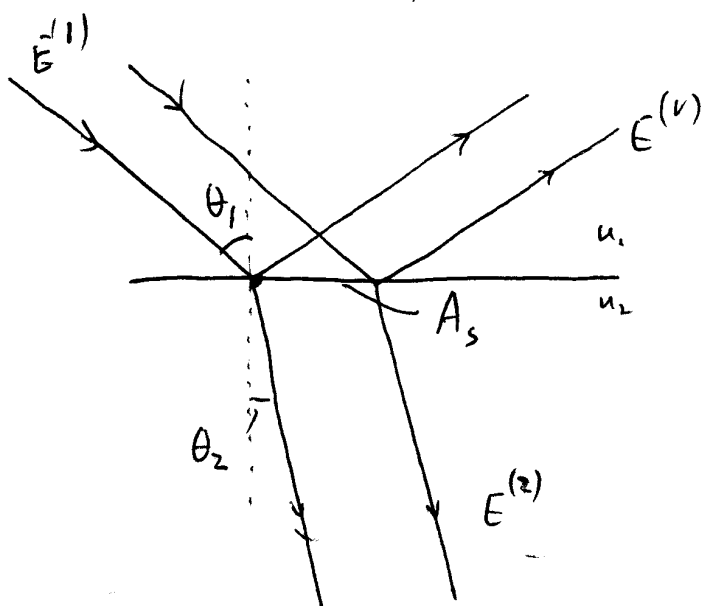

A_s is the illuminated area at the interface. The total incident energy per unit time

$$W_i = \frac{1}{2\mu_0} n_1 |\vec{E}^{(i)}|^2 \cdot A_s \cdot \cos \theta_1$$

Similarly,

$$W_r = \frac{1}{2\mu_0} n_1 |\vec{E}^{(r)}|^2 \cdot A_s \cdot \cos \theta_1$$

$$W_t = \frac{1}{2\mu_0} n_2 |\vec{E}^{(t)}|^2 \cdot A_s \cdot \cos \theta_2$$

Energy conservation requires

$$W_i = W_r + W_t = W_i (R + T)$$

or

$$n_1 \cos \theta_i = n_1 \cos \theta_r |r|^2 + n_2 \cos \theta_t |t|^2$$

or

$$1 = |r|^2 + \frac{n_2 \cos \theta_t}{n_1 \cos \theta_i} |t|^2$$

regardless for v_s & t_s or v_p & t_p .

(Prove this is satisfied by the Fresnel's equations for t_s, v_s ; t_p, v_p)

Reflectance R :

$$R \equiv \frac{W_r}{W_i} = |r|^2$$

Transmittance T :

$$T \equiv \frac{W_t}{W_i} = \frac{n_2 \cos \theta_t}{n_1 \cos \theta_i} |t|^2 \quad (\text{even if } |t| > 1, T \leq 1)$$

General Derivation of Fresnel equations (Zhu)

TM waves

$$\vec{k}^{(1)} = n_1 \frac{\omega}{c} (\sin \theta_1, 0, \cos \theta_1) = n_1 \frac{2\pi}{\lambda} (\sin \theta_1, 0, \cos \theta_1)$$

$$\vec{k}^{(r)} = n_1 \frac{\omega}{c} (\sin \theta_r, 0, -\cos \theta_r) = n_1 \frac{2\pi}{\lambda} (\sin \theta_r, 0, -\cos \theta_r)$$

$$\vec{k}^{(2)} = (k_{2x}, 0, k_{2z}) = (k_x^{(2)}, 0, k_z^{(2)})$$

Since $(k_x^{(1)})^2 + (k_z^{(1)})^2 = (k^{(1)})^2 = \vec{k}^{(1)} \cdot \vec{k}^{(1)} = k_2 \left(\frac{2\pi}{\lambda}\right)^2$, and

$$k_x^{(2)} = k_x^{(1)} = n_1 \left(\frac{2\pi}{\lambda}\right) \sin \theta_1$$

We have

$$\begin{aligned} \vec{k}^{(2)} &= \left(n_1 \frac{2\pi}{\lambda} \sin \theta_1, 0, \frac{2\pi}{\lambda} \sqrt{k_2 - n_1^2 \sin^2 \theta_1} \right) \\ &= \left(n_1 \frac{2\pi}{\lambda} \sin \theta_1, 0, \sqrt{k_2} \frac{2\pi}{\lambda} \sqrt{1 - \frac{n_1^2}{k_2} \sin^2 \theta_1} \right) \\ &\equiv \sqrt{k_2} \frac{2\pi}{\lambda} \left(\sin \tilde{\theta}_2, 0, \cos \tilde{\theta}_2 \right) \end{aligned}$$

$$\cos \tilde{\theta}_2 \equiv \sqrt{1 - \frac{n_1^2}{k_2} \sin^2 \theta_1}, \quad \sin \tilde{\theta}_2 = \sqrt{1 - \cos^2 \tilde{\theta}_2} = \frac{n_1 \sin \theta_1}{\sqrt{k_2}}$$

$$\left(\text{so } \sqrt{k_2} \sin \tilde{\theta}_2 = n_1 \sin \theta_1 \right)$$

Let $\vec{E}_p^{(2)} = E_{px}^{(2)} \hat{x} + E_{pz}^{(2)} \hat{z} = (E_{px}, 0, E_{pz})$, then

$$\vec{E}_p^{(2)} \cdot \vec{E}_p^{(2)} \equiv (E_p^{(2)})^2 = (E_{px}^{(2)})^2 + (E_{pz}^{(2)})^2$$

$$\Rightarrow E_p^{(2)} = \sqrt{(E_{px}^{(2)})^2 + (E_{pz}^{(2)})^2}$$

Since $\vec{k}^{(2)} \cdot \vec{E}_p^{(2)} = 0$ (transversality), we have naturally

$$\begin{aligned} \vec{E}_p^{(2)} &= E_p^{(2)} \cos \tilde{\alpha}_2 \hat{x} + E_p^{(2)} (-\sin \tilde{\alpha}_2) \hat{z} \\ &= E_p^{(2)} (\cos \tilde{\alpha}_2, 0, -\sin \tilde{\alpha}_2) \end{aligned}$$

(Remember $\sin^2 \tilde{\alpha}_2 + \cos^2 \tilde{\alpha}_2 = 1$)

From $cB_{1t} = cB_{2t}$:

$$n_1 E_p^{(1)} - n_1 \tilde{E}_p^{(1)} = \sqrt{k_2} E_p^{(2)}$$

From $\vec{E}_{1t} = \vec{E}_{2t}$:

$$E_p^{(1)} \cos \alpha_1 + \tilde{E}_p^{(1)} \cos \alpha_1 = E_p^{(2)} \cos \tilde{\alpha}_2$$

Since $\sqrt{k_2} = \tilde{n}_2$, we have

$$t_p = \frac{2n_1 \cos \alpha_1}{n_1 \cos \tilde{\alpha}_2 + \tilde{n}_2 \cos \alpha_1} \equiv \frac{E_p^{(2)}}{E_p^{(1)}}$$

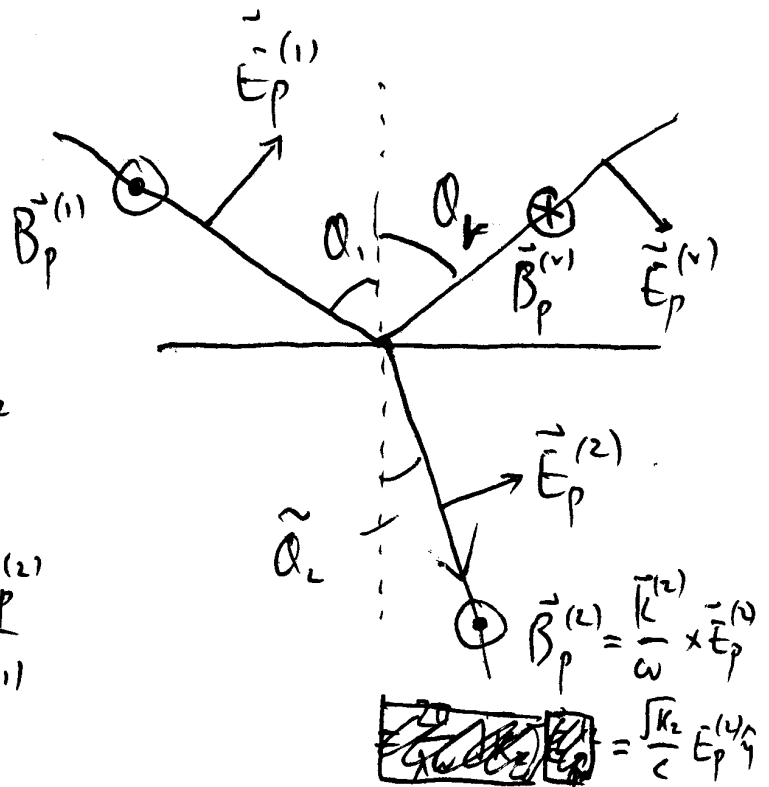

and

$$V_p = \frac{n_1 \cos \tilde{\alpha}_2 - \tilde{n}_2 \cos \alpha_1}{\tilde{n}_2 \cos \alpha_1 + n_1 \cos \tilde{\alpha}_2} = \frac{\tilde{E}_p^{(v)}}{E_p^{(i)}}$$

TE waves:

From $E_{1t} = E_{2t}$:

$$E_s^{(i)} + E_s^{(v)} = E_s^{(2)}$$

From $\epsilon B_{1t} = \epsilon B_{2t}$:

$$-n_1 \cos \alpha_1 E_s^{(i)} + n_1 \cos \alpha_1 E_s^{(v)} = -\tilde{n}_2 \cos \tilde{\alpha}_2 E_s^{(2)}$$

Finally,

$$t_s = \frac{2n_1 \cos \alpha_1}{n_1 \cos \alpha_1 + \tilde{n}_2 \cos \tilde{\alpha}_2} = \frac{E_s^{(2)}}{E_s^{(i)}}$$

$$r_s = \frac{n_1 \cos \alpha_1 - \tilde{n}_2 \cos \tilde{\alpha}_2}{n_1 \cos \alpha_1 + \tilde{n}_2 \cos \tilde{\alpha}_2} = \frac{E_s^{(v)}}{E_s^{(i)}}$$

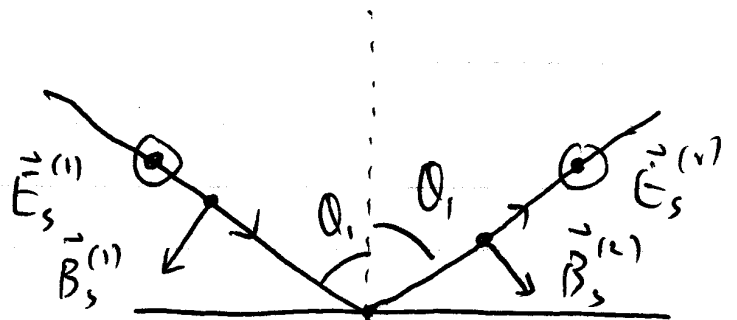

$$\tilde{\alpha}_2 \quad \vec{E}_s^{(2)}$$

$$\vec{B}_s^{(2)} = \frac{\sqrt{\epsilon_2}}{c} \hat{k}^{(2)} \times \vec{E}_s^{(2)}$$

$$= \frac{\sqrt{\epsilon_2}}{c} E_s^{(2)} (-\cos \tilde{\alpha}_2, 0, \sin \tilde{\alpha}_2)$$

(Remember: $\tilde{n}_2 = \sqrt{\epsilon_2}$, $\cos \tilde{\alpha}_2 = \sqrt{1 - \frac{n_1^2}{\epsilon_2} \sin^2 \alpha_1}$)

Total internal reflection at the interface between an optically dense medium (n_1) and an optically thin medium ($n_2 < n_1$)

From Snell's law of refraction,

$$n_1 \sin \theta_1 = n_2 \sin \theta_2$$

$\theta_2 > \theta_1$. There exists an angle θ_c at which $\theta_2 = 90^\circ$:

$$n_1 \sin \theta_c = n_2 \sin 90^\circ$$

$$\therefore \sin \theta_c = \frac{n_2}{n_1}$$

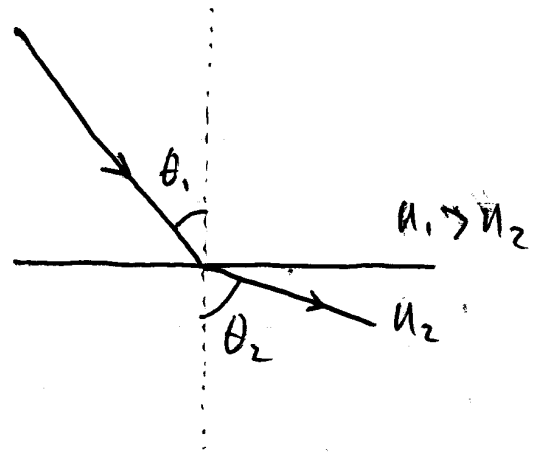

This angle is always larger than the corresponding Brewster angle θ_b as

$$\tan \theta_b = \frac{n_2}{n_1} \Rightarrow \sin \theta_b = \frac{n_2}{n_1} \cos \theta_b < \frac{n_2}{n_1} = \sin \theta_c$$

When the incident angle $\theta_1 > \theta_c$, θ_2 doesn't exist. But \vec{E} field on n_2 -side is non-vanishing, only there is no e.m. wave propagating away from the interface. The electric field on n_2 -side is called "evanescent wave". In this case, the incident energy is totally reflected (sent back to n_1 -medium).

$$\cos \tilde{\theta}_2 = \sqrt{1 - \left(\frac{n_1}{n_2}\right)^2 \sin^2 \theta_1} = i \sqrt{\left(\frac{n_1}{n_2}\right)^2 \sin^2 \theta_1 - 1} = i\alpha$$

$$\begin{aligned}
 r_p &= \frac{n_1 \cos \tilde{\theta}_2 - n_2 \cos \theta_1}{n_2 \cos \theta_1 + n_1 \cos \tilde{\theta}_2} = -\frac{n_2 \cos \theta_1 - i n_1 \alpha}{n_2 \cos \theta_1 + i n_1 \alpha} \\
 &= e^{i\left(\pi - \tan^{-1} \frac{n_1 \alpha}{n_2 \cos \theta_1} \cdot 2\right)} \\
 &= e^{i2\left(\frac{\pi}{2} - \tan^{-1} \frac{n_1 \alpha}{n_2 \cos \theta_1}\right)} = e^{i\phi_p}
 \end{aligned}$$

$$R_p \equiv |r_p|^2 = 1$$

$$\begin{aligned}
 r_s &= \frac{n_1 \cos \theta_1 - n_2 \cos \tilde{\theta}_2}{n_1 \cos \theta_1 + n_2 \cos \tilde{\theta}_2} = \frac{n_1 \cos \theta_1 - i n_2 \alpha}{n_1 \cos \theta_1 + i n_2 \alpha} \\
 &= e^{-i2 \tan^{-1} \frac{n_2 \alpha}{n_1 \cos \theta_1}} \\
 &= e^{i\phi_s}
 \end{aligned}$$

$$R_s \equiv |r_s|^2 = 1$$

Total internal reflection

Evanescence wave: ($t_s \neq 0, t_p \neq 0$)

When the total reflection occurs, the transmitted electric field in ϵ_2 is not zero, but decreases exponentially from the interface:

$$k_z^{(+)} = \frac{\omega}{c} n_2 \cos \tilde{\theta}_t = i \frac{2\pi}{\lambda_0} n_2 \sqrt{\left(\frac{n_1}{n_2}\right)^2 \sin^2 \theta_i - 1}$$

$$\vec{E}_{s,p}^{(+)} = \vec{E}_{s,p}^{(+)} e^{-\frac{2\pi}{\lambda_0} \sqrt{(n_1 \sin \theta_i)^2 - n_2^2} \cdot z}$$

The penetration depth (by 1/e-point of $I_{s,p}$)

$$\delta_{\text{evanescence}} = \frac{\lambda_0}{4\pi} \cdot \frac{1}{\sqrt{n_1^2 \sin^2 \theta_i - n_2^2}}$$

(Surface studies, optical microscopy)

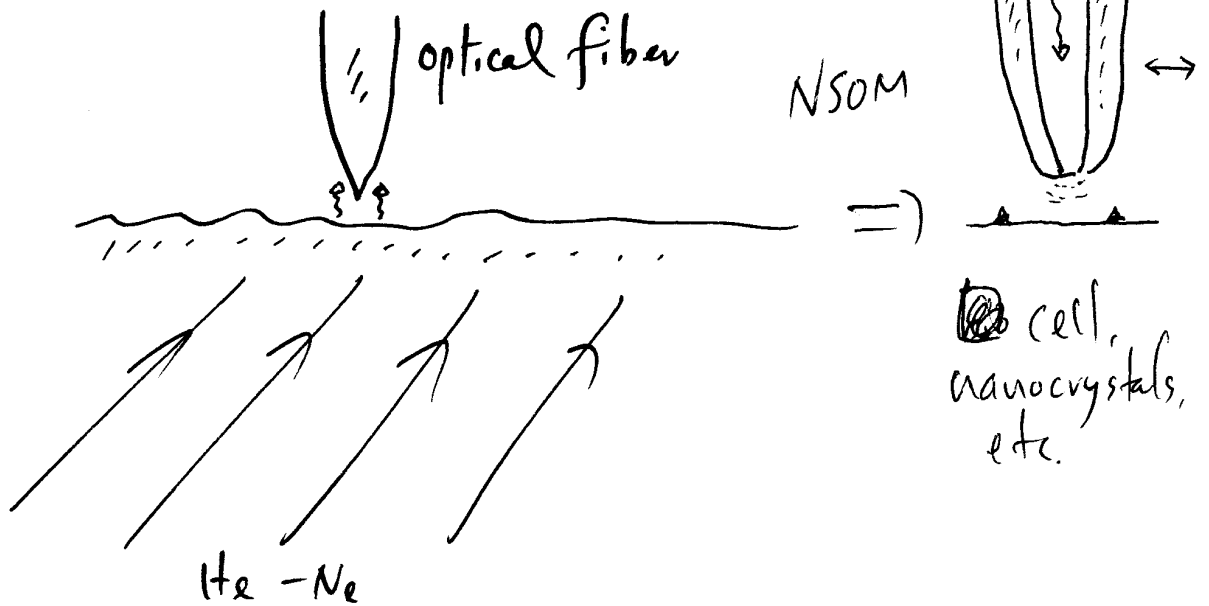

Reflection and transmission at interface between an insulator (including vacuum or air) and a metal with $\epsilon_2 = \epsilon_2' + i\epsilon_2''$.

$$\begin{aligned}\tilde{\cos\theta_2} &= \sqrt{1 - \frac{n_1^2 \sin^2\theta_1}{\epsilon_2}} \\ &= \frac{\sqrt{\epsilon_2 - n_1^2 \sin^2\theta_1}}{\sqrt{\epsilon_2}}\end{aligned}$$

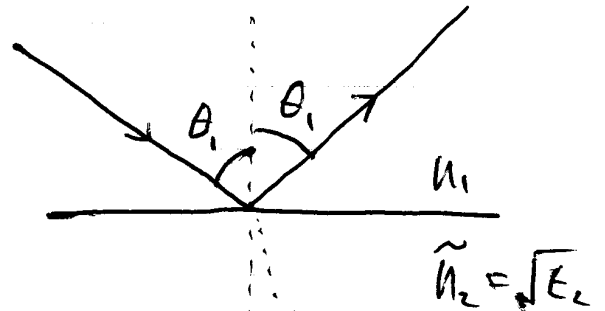

$$V_p = \frac{n_1 \tilde{\cos\theta_2} - \tilde{n}_2 \cos\theta_1}{n_1 \tilde{\cos\theta_2} + \tilde{n}_2 \cos\theta_1}$$

$$\begin{aligned}\tilde{n}_2 &\equiv \sqrt{\epsilon_2} = n_{2R} + i n_{2I} \\ &= n_2 + i k_2\end{aligned}$$

$$= \frac{n_1 \sqrt{\epsilon_2 - n_1^2 \sin^2\theta_1} - \epsilon_2 \cos\theta_1}{n_1 \sqrt{\epsilon_2 - n_1^2 \sin^2\theta_1} + \epsilon_2 \cos\theta_1}$$

$$= \frac{n_1 \sqrt{(n_{2R} + i n_{2I})^2 - n_1^2 \sin^2\theta_1} - (n_{2R} + i n_{2I})^2 \cos\theta_1}{n_1 \sqrt{(n_{2R} + i n_{2I})^2 - n_1^2 \sin^2\theta_1} + (n_{2R} + i n_{2I})^2 \cos\theta_1}$$

$$V_s = \frac{n_1 \cos\theta_1 - \tilde{n}_2 \tilde{\cos\theta_2}}{n_1 \cos\theta_1 + \tilde{n}_2 \tilde{\cos\theta_2}}$$

$$= \frac{n_1 \cos\theta_1 - \sqrt{(n_{2R} + i n_{2I})^2 - n_1^2 \sin^2\theta_1}}{n_1 \cos\theta_1 + \sqrt{(n_{2R} + i n_{2I})^2 - n_1^2 \sin^2\theta_1}}$$

At normal incidence, $\theta_i = 0$,

$$V_p(\theta_i = 0) = \frac{u_1 - (u_{2R} + i u_{2I})}{u_1 + (u_{2R} + i u_{2I})} = V_s(\theta_i = 0)$$

$$R_p(\theta_i = 0) = |V_p(\theta_i = 0)|^2 = \frac{(u_1 - u_{2R})^2 + u_{2I}^2}{(u_1 + u_{2R})^2 + (u_{2I})^2}$$

$$K_{ze} = K_z = \left(\frac{2\pi}{\lambda}\right) \tilde{u}_z = \left(\frac{2\pi}{\lambda}\right) \cdot u_{2R} + i \left(\frac{2\pi}{\lambda}\right) u_{2I}$$

$$\begin{aligned} E_z(z) &= E_i \cdot t_p(\theta_i = 0) \cdot e^{i K_{ze} z} \\ &= E_i \cdot t_p(\theta_i = 0) \cdot e^{i \frac{2\pi}{\lambda} u_{2R} z} \cdot e^{-\frac{2\pi}{\lambda} u_{2I} z} \end{aligned}$$

$$I_z(z) = I_z(z=0) e^{-\frac{4\pi}{\lambda} u_{2I} z}$$

Skin depth δ (the distance at which $I_z(\delta) = I_z(z=0)/e$).

$$\delta = \frac{\lambda}{4\pi \cdot u_{2I}}$$

7. Total reflection by a metal with

$$\epsilon(\omega) = 1 - \frac{\omega_p^2}{\omega^2} < 0$$

In this case (let $\epsilon(\omega) = n_2^2$)

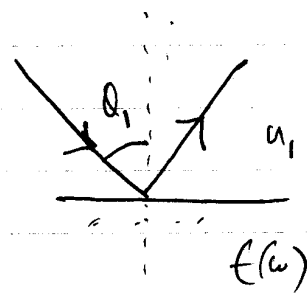

$$n_2 \cos \theta_t = \sqrt{\epsilon(\omega) - n_1^2 \sin^2 \theta_i}$$

$$= i \sqrt{|\epsilon(\omega)| + n_1^2 \sin^2 \theta_i}$$

$$n_2 = \sqrt{\epsilon(\omega)} = i \sqrt{|\epsilon(\omega)|}$$

$$\cos \theta_t = \sqrt{1 + \frac{n_1^2}{|\epsilon(\omega)|} \sin^2 \theta_i} > 0$$

$$\therefore r_s = - \frac{n_2 \cos \theta_t - n_1 \cos \theta_i}{n_2 \cos \theta_t + n_1 \cos \theta_i} = e^{i\phi_s}$$

$$r_p = \frac{n_1 \cos \theta_t - n_2 \cos \theta_i}{n_1 \cos \theta_t + n_2 \cos \theta_i} = e^{i\phi_p}$$

$$|r_s|^2 = 1, \quad |r_p|^2 = 1$$

Multiple-layer thin film optics

— reflection and transmission in the presence of a stack of heterogeneous films

Fabry-Pérot interferometer (etalon)

Optical coating

Optical characterization of material/biological processes.

Goal: relate the incident electric field $E_0^{(i)}$ to the reflected field $E_0^{(r)}$ and the transmitted field $E_N^{(t)}$ through the "matrix" that connects the electromagnetic fields (total) at each interface.

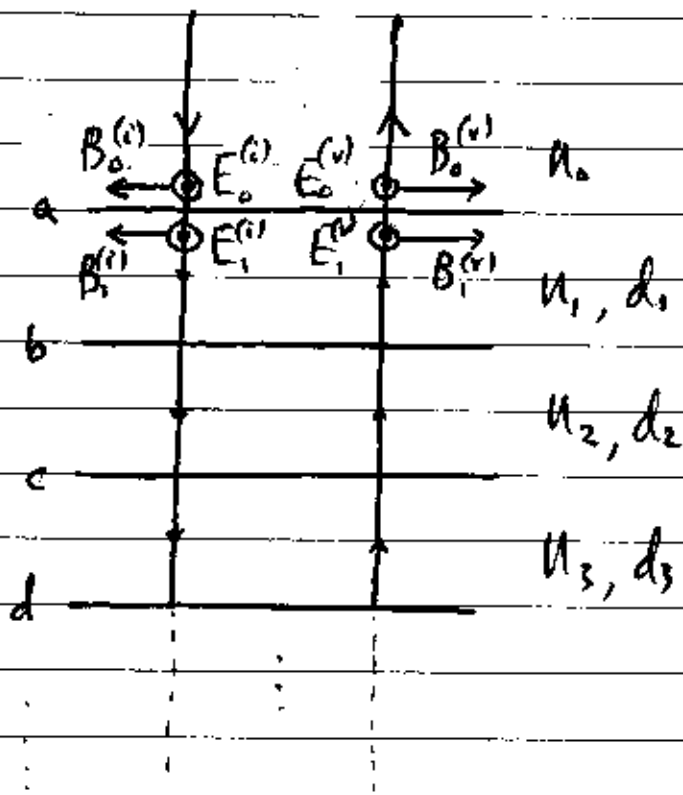

At the first interface, n_0 -side:

$$E_a = E_1^{(i)}(a) + E_1^{(r)}(a) \quad (1)$$

$$cBa = n_1 E_1^{(i)}(a) - n_0 E_1^{(r)}(a) \quad (2)$$

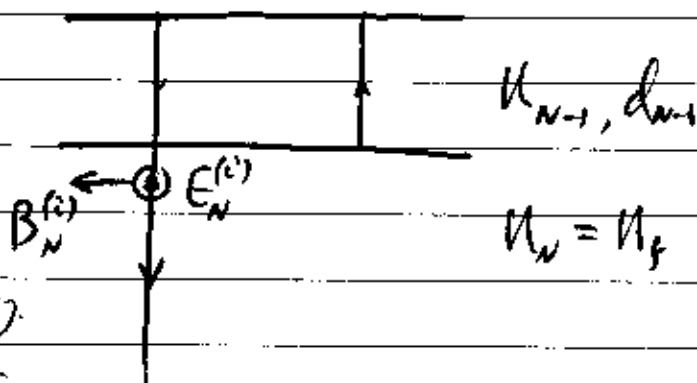

At the second interface, on n_1 -side,

$$E_b = E_1^{(i)} e^{i\phi_1} + E_1^{(r)} e^{-i\phi_1} \dots \textcircled{3}$$

$$cB_b = n_1 E_1^{(i)} e^{i\phi_1} - n_1 E_1^{(r)} e^{-i\phi_1} \dots \textcircled{4}$$

$$\phi_1 = \frac{2\pi}{\lambda} n_1 d_1, \text{ generally, } \phi_j = \frac{2\pi}{\lambda} n_j d_j, \quad cB_j = n_j E_j^{(i)}$$

From $\textcircled{3}$ and $\textcircled{4}$:

$$E_1^{(i)} = \frac{n_1 E_b + cB_b}{2n_1} e^{-i\phi_1} \dots \textcircled{5}$$

$$E_1^{(r)} = \frac{n_1 E_b - cB_b}{2n_1} e^{i\phi_1} \dots \textcircled{6}$$

From $\textcircled{1}$ and $\textcircled{2}$:

$$E_a = E_b \cos\phi_1 + cB_b \frac{\sin\phi_1}{in_1}$$

$$cB_a = E_b \frac{n_1 \sin\phi_1}{i} + cB_b \cos\phi_1$$

$$\begin{pmatrix} E_a \\ cB_a \end{pmatrix} = \begin{pmatrix} \cos\phi_1 & \frac{\sin\phi_1}{in_1} \\ \frac{n_1 \sin\phi_1}{i} & \cos\phi_1 \end{pmatrix} \begin{pmatrix} E_b \\ cB_b \end{pmatrix} \equiv M_1 \begin{pmatrix} E_b \\ cB_b \end{pmatrix}$$

Repeat the process for the subsequent layers,

$$\begin{pmatrix} E_a \\ CB_a \end{pmatrix} = M_1 M_2 \dots M_j \dots M_{N-1} \begin{pmatrix} E_N^{(i)} \\ n_N E_N^{(i)} \end{pmatrix} \equiv M \begin{pmatrix} E_N^{(i)} \\ n_N E_N^{(i)} \end{pmatrix}$$

$$M \equiv M_1 M_2 \dots M_j \dots M_{N-1}$$

$$M_j \equiv \begin{pmatrix} \cos \phi_j & \frac{\sin \phi_j}{i n_j} \\ \frac{n_j \sin \phi_j}{i} & \cos \phi_j \end{pmatrix}, \quad \phi_j \equiv \frac{2\pi}{\lambda} n_j d_j$$

$$\text{Let } M = \begin{pmatrix} M_{11} & M_{12} \\ M_{21} & M_{22} \end{pmatrix}$$

$$\text{From } E_a = E_0^{(i)} + E_0^{(r)}$$

$$CB_a = n_0 E_0^{(i)} - n_0 E_0^{(r)}$$

$$E_0^{(i)} = \frac{n_0 E_a + CB_a}{2n_0} \quad (7)$$

$$E_0^{(r)} = \frac{n_0 E_a - CB_a}{2n_0} \quad (8)$$

2

$$\begin{pmatrix} \epsilon_0^{(i)} \\ \epsilon_0^{(v)} \end{pmatrix} = \begin{pmatrix} \frac{1}{2} & \frac{1}{2u_0} \\ \frac{1}{2} & -\frac{1}{2u_0} \end{pmatrix} \begin{pmatrix} \epsilon_n \\ c\beta_n \end{pmatrix}$$

$$= \begin{pmatrix} \frac{1}{2} & \frac{1}{2u_0} \\ \frac{1}{2} & -\frac{1}{2u_0} \end{pmatrix} \begin{pmatrix} M_{11} & M_{12} \\ M_{21} & M_{22} \end{pmatrix} \begin{pmatrix} \epsilon_N^{(i)} \\ u_f \epsilon_N^{(i)} \end{pmatrix}$$

$$= \begin{pmatrix} \frac{1}{2u_0} (u_0 M_{11} + M_{21}) & \frac{1}{2u_0} (u_0 M_{12} + M_{22}) \\ \frac{1}{2u_0} (u_0 M_{11} - M_{21}) & \frac{1}{2u_0} (u_0 M_{12} - M_{22}) \end{pmatrix} \begin{pmatrix} \epsilon_N^{(i)} \\ u_f \epsilon_N^{(i)} \end{pmatrix}$$

From

$$\epsilon_0^{(i)} = \frac{1}{2u_0} \left[u_0 M_{11} + M_{21} + u_f (u_0 M_{12} + M_{22}) \right] \epsilon_N^{(i)}$$

$$t \equiv \frac{\epsilon_n^{(v)}}{\epsilon_0^{(i)}} = \frac{2u_0}{u_0 M_{11} + M_{21} + u_f (u_0 M_{12} + M_{22})}$$

$$Y \equiv \frac{\epsilon_0^{(v)}}{\epsilon_0^{(i)}} = \frac{\epsilon_0^{(v)}}{\epsilon_n^{(i)}} \cdot \frac{\epsilon_n^{(i)}}{\epsilon_0^{(i)}} = \frac{u_0 M_{11} - M_{21} + u_f (u_0 M_{12} - M_{22})}{u_0 M_{11} + M_{21} + u_f (u_0 M_{12} + M_{22})}$$

check the expressions in the vacuum limit:

Case #1: Only one interface separating n_0 & n_f ,
 $\phi_j = \frac{2\pi}{\lambda} n_j d_j = 0$ for all j

$$M_j = \begin{pmatrix} 1 & 0 \\ 0 & 1 \end{pmatrix}, \quad M = \begin{pmatrix} 1 & 0 \\ 0 & 1 \end{pmatrix}$$

$$t = \frac{2n_0}{n_0 + n_f}$$

$$r = \frac{n_0 - n_f}{n_0 + n_f}$$

Case #2: Fabry-Pérot, only one layer in between,

$$\phi = \frac{2\pi}{\lambda} n d$$

$$M = M_1 = \begin{pmatrix} \cos \phi & \frac{\sin \phi}{i n} \\ \frac{i n \sin \phi}{i} & \cos \phi \end{pmatrix}$$

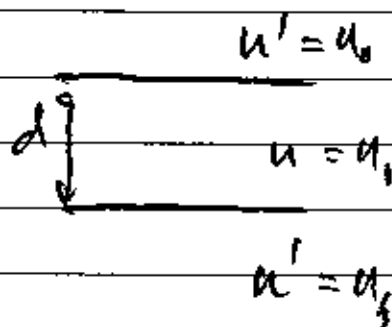

$$t = \frac{2n_1}{n_0 \cos \phi + n_1 \sin \phi / i + n_f (n_1 \sin \phi / i + \cos \phi)}$$

$$T = |t|^2 = \frac{1}{1 + \frac{4r^2}{\sin^2 \phi}}, \quad r^2 = \frac{4r^2}{(1-r)^2}, \quad r = \frac{n - n'}{n + n'} \quad *$$

$\lambda/4 - \lambda/4$ antireflection coatings

$$\phi_1 = \frac{2\pi}{\lambda} n_1 d_1 = \frac{\pi}{2} \quad (\lambda/4)$$

$$\phi_2 = \frac{2\pi}{\lambda} n_2 d_2 = \frac{\pi}{2} \quad (\lambda/4)$$

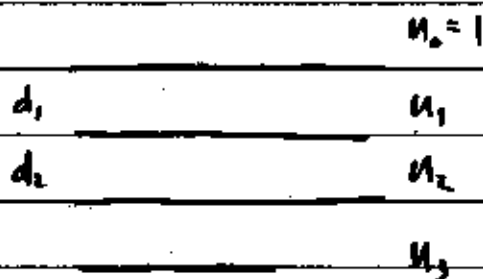

$$M = \begin{pmatrix} 0 & \frac{1}{i n_1} \\ \frac{n_1}{i} & 0 \end{pmatrix} \begin{pmatrix} 0 & \frac{1}{i n_2} \\ \frac{n_2}{i} & 0 \end{pmatrix}$$

$$\begin{pmatrix} -\frac{n_2}{n_1} & 0 \\ 0 & -\frac{n_1}{n_2} \end{pmatrix}$$

$$n_0 M_{11} + n_3 n_2 M_{22} - M_{21} - n_3 M_{12}$$

$$n_0 M_{11} + n_0 n_3 M_{12} + M_{21} + n_3 M_{22}$$

$$= \frac{n_0 \left(-\frac{n_2}{n_1}\right) + n_3 \left(\frac{n_1}{n_2}\right)}{-n_0 \left(\frac{n_2}{n_1}\right) - n_3 \frac{n_1}{n_2}}$$

$$= \frac{n_0 n_2^2 - n_3 n_1^2}{n_0 n_2^2 + n_3 n_1^2}$$

To minimize r , $n_0 n_2^2 = n_3 n_1^2 \Rightarrow \frac{n_2}{n_1} = \sqrt{\frac{n_3}{n_0}}$

$\frac{\lambda}{4} - \frac{\lambda}{4}$ reflection coatings:

$$\phi_1 = \frac{2\pi}{\lambda_0} n_1 d_1 = \frac{\pi}{2}$$

$$\phi_2 = \frac{2\pi}{\lambda_0} n_2 d_2 = \frac{\pi}{2}$$

$$M = \begin{pmatrix} 0 & \frac{1}{i n_1} \\ n_1 & 0 \end{pmatrix} \begin{pmatrix} 0 & \frac{1}{i n_2} \\ n_2 & 0 \end{pmatrix}$$

$$= \begin{pmatrix} -\frac{n_2}{n_1} & 0 \\ 0 & -\frac{n_1}{n_2} \end{pmatrix}$$

$$M^{2N} = \begin{pmatrix} \left(\frac{n_2}{n_1}\right)^{2N} & 0 \\ 0 & \left(\frac{n_1}{n_2}\right)^{2N} \end{pmatrix}$$

Let $n_2 > n_1 \Rightarrow \left(\frac{n_2}{n_1}\right)^{2N} \gg 1, \left(\frac{n_1}{n_2}\right)^{2N} \ll 1$

$$r = \frac{n_0 M_{11} - n_3 M_{22}}{n_0 M_{11} + n_3 M_{22}} \approx 1 - 2 \left(\frac{n_3}{n_0}\right) \left(\frac{n_1}{n_2}\right)^{4N} \approx 1$$

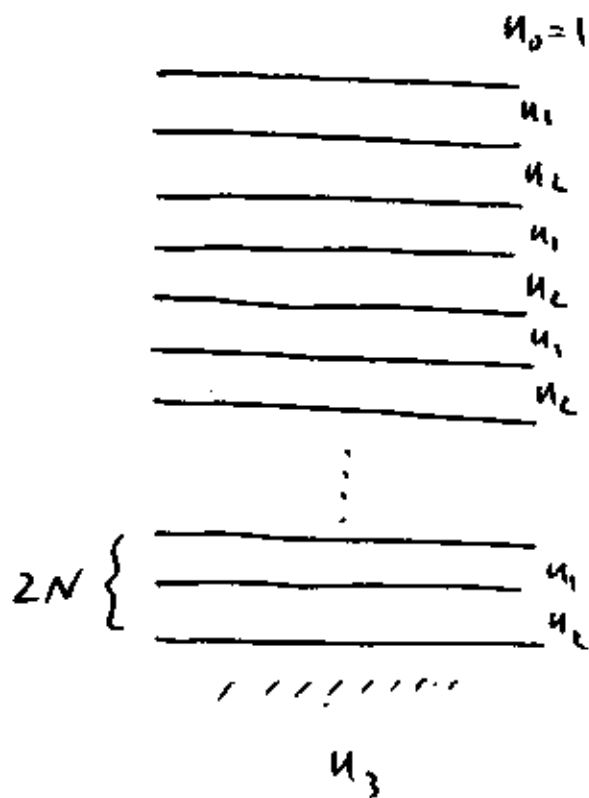

~ 0
#

Optical dielectric constant.

$$\left\{ \begin{array}{l} \nabla^2 \vec{E} = \epsilon \epsilon_0 \mu_0 \frac{\partial^2 \vec{E}}{\partial t^2} \\ c = c_0 \epsilon, \quad \vec{E} = \vec{E}_0 / \epsilon \end{array} \right. \quad n = \sqrt{\epsilon} \quad v = \frac{c}{n}$$

Dielectric constant ϵ

$$\vec{E}_0 = \hat{e}_0 \frac{Q_f}{\epsilon_0 A} \quad \vec{E} = \frac{Q_f - Q_b}{\epsilon_0 A} \vec{e}_0$$

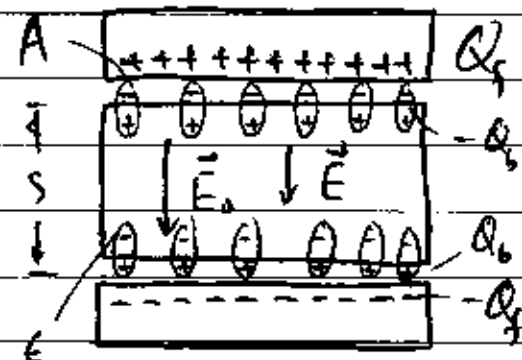
$$\epsilon \equiv \frac{\epsilon_0}{\epsilon} = \frac{Q_f}{Q_f - Q_b} \quad \frac{Q_b}{Q_f} = \frac{\epsilon - 1}{\epsilon}$$

\vec{E} induces an extra dipole moment in the molecular constituent by pulling the opposite charges along the two opposing direction parallel to \vec{E} . The volume density of the induced dipole moment is defined as the polarization vector

$$\vec{P} = \frac{\sum \vec{p}_{ind}}{\Delta V} = \epsilon_0 \chi \vec{E}, \quad \chi = \frac{\vec{P}}{\epsilon_0 \vec{E}}, \quad \vec{D} = \epsilon_0 \vec{E} + \vec{P}$$

$$\vec{P} = \frac{Q_b \cdot s}{(A \cdot s)} \hat{e} = \frac{Q_b}{A} \hat{e} \Rightarrow \chi = \frac{Q_b}{\epsilon_0 A E} = \frac{Q_b \epsilon}{\epsilon_0 A E_0} = \frac{Q_b}{Q_f} \epsilon = \epsilon - 1$$

$$\Rightarrow \epsilon = 1 + \chi, \quad n = \sqrt{\epsilon} = \sqrt{1 + \chi}$$

Simple derivation of $k = 1 + X$

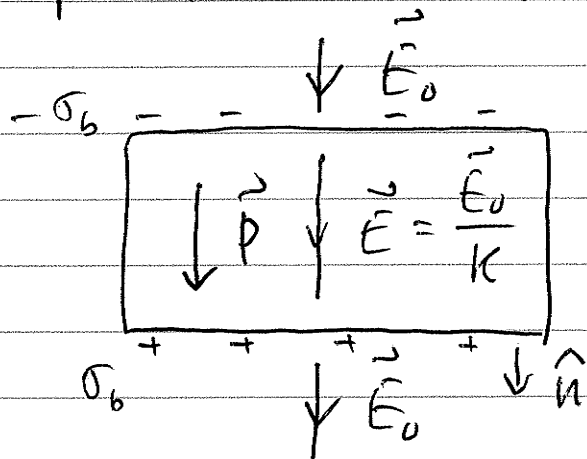

$$\vec{E} = \frac{\vec{E}_0}{k} = \vec{E}_0 + \vec{E}_p$$

$$\vec{P} = \epsilon_0 \chi \vec{E} = X \epsilon_0 \vec{E}$$

$$\sigma_b = \hat{n} \cdot \vec{P} = X \epsilon_0 E$$

$$\vec{E}_p = \frac{\sigma_b}{\epsilon_0} (-\hat{E}) = -X \vec{E}$$

$$\therefore \vec{E} = \frac{\vec{E}_0}{k} = \vec{E}_0 - X \vec{E}$$

$$\therefore \vec{E} (1 + X) = \vec{E}_0$$

$$\therefore k = 1 + X$$

✱

Calculation of χ_e and k (Nucleus: immobile
Electrons: mobile)

In an oscillating electric field, only electrons are moved by the field (Coulomb's law):

$$\vec{E}(t) = \vec{E} e^{-i\omega t}$$

(electrons are much lighter, $1/2000$)

Newton's eqn.

$$m_e \frac{d^2 \vec{r}}{dt^2} = -k \vec{r} - m_e \rho \frac{d\vec{r}}{dt} + Z_e \vec{E} e^{-i\omega t}$$

↓
restoring
force by
nucleus

↓
friction
force that
damps the
electron motion

⇒ external
force by the
e.m. field

The induced electron displacement follows $\vec{E}(t)$ with the same time dependence:

$$\vec{r}_{ind}(t) = \vec{r}_{ind} e^{-i\omega t}$$

$$\therefore -\omega^2 m_e \vec{r}_{ind} = -k \vec{r}_{ind} + i m_e \omega \rho \vec{r}_{ind} + Z_e \vec{E}$$

$$\therefore \vec{r}_{ind} = \frac{Z_e / m_e}{(k/m_e) - \omega^2 - i\omega\rho} \vec{E}$$

Define: $\omega_0^2 = k/m_e$ (k : spring constant)
 = transition frequency (eas)

$$\vec{v}_{ind} = \frac{ze/m_e}{\omega_0^2 - \omega^2 - i\omega\Gamma} \vec{E}$$

Induced polarisation vector \vec{P}

$$\vec{P} = N_b \cdot z e \cdot \vec{v}_{ind} = \frac{N_b z^2 e^2 / m_e}{\omega_0^2 - \omega^2 - i\omega\Gamma} \vec{E}$$

Linear susceptibility χ_e and dielectric constant k

$$\chi_e(\omega) = \frac{\vec{P}}{\vec{E}} = \frac{N_b \cdot z^2 e^2 / m_e}{\omega_0^2 - \omega^2 - i\omega\Gamma}$$

$$k(\omega) = 1 + \frac{\chi_e}{\epsilon_0} = 1 + \frac{N_b \cdot z^2 e^2 / m_e \cdot \epsilon_0}{\omega_0^2 - \omega^2 - i\omega\Gamma}$$

Plasma frequency ω_p :

$$\omega_p^2 = \frac{N_b z^2 e^2}{m_e \epsilon_0} = \frac{N_b \cdot e^2}{m_e \epsilon_0}$$

$$k(\omega) = 1 + \frac{\omega_p^2}{\omega_0^2 - \omega^2 - i\omega\Gamma}$$

$$\text{Cu: } N_b = 8.93 \times 10^{28}$$

$$\epsilon_0 = 8.85 \times 10^{-12}$$

$$e = 1.6 \times 10^{-19} \text{ Coulomb}$$

$$\omega_p^2 = 2.8 \times 10^{32} \text{ Hz}^2$$

$$\omega_p = 1.65 \times 10^{16} \text{ Hz}$$

2. Optical constant of metals and insulators:

Visible frequency range: 2.7×10^{15} Hz (red) - 5×10^{15} Hz (purple)

Metals (Drude model)

free electrons with m_e , N_e and spring constant $K=0$,

$$\omega_p^2 = \frac{4\pi N_e e^2}{m_e} \quad \text{or} \quad \omega_p^2 = \frac{N_e e^2}{m_e \epsilon_0} \quad (\text{MKSA})$$

$$\epsilon(\omega) = 1 - \frac{\omega_p^2}{\omega^2 - \omega \Gamma i}$$

Typically, $\Gamma = 10^{13}$ Hz, $\omega_p = 10^{16}$ Hz, for $\omega \gg \Gamma$,

$$\epsilon(\omega) \approx 1 - \frac{\omega_p^2}{\omega^2}$$

When ω is in the visible range, $\epsilon(\omega) < 0$, the light is totally reflected

\Rightarrow silver, aluminium appear silver white.

Exception: Cu has natural resonances starting at orange color, thus red & orange light are reflected, yellow through purple light are partly passing through \Rightarrow Cu, Au are reddish & yellowish. #

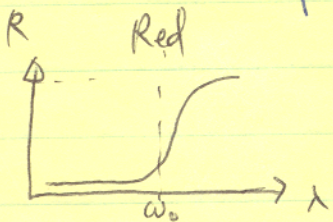

Optical constants for insulators and semiconductors

$k \neq 0$, natural frequency $\omega_0 \gg \omega$, ω_0 in ultraviolet range

$$\epsilon(\omega) = 1 + \frac{q_0 N_0 e^2 / m}{\omega_0^2 - \omega^2} \approx 1 + \frac{\omega_p^2}{\omega_0^2} > 1$$

$$N(\omega) = \sqrt{\epsilon} = n > 1 \quad \leftarrow \frac{N_0 e^2}{m \epsilon_0}$$

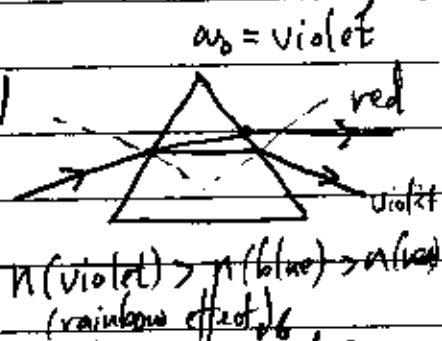

Insulators are transparent in visible range ($\omega_0 \geq 10^{15}$ Hz)

$$n(\text{water}) = 1.33$$

$$n(\text{plastic}) = 1.3$$

$$n(\text{glass}) = 1.45 - 2.7$$

$$n_{\text{air}} \approx 1 + 10^{-3} \left(\frac{1}{\lambda^2} - 1 \right) = 1.0005$$

Semiconductor transparent in near IR range ($\omega_0 \sim 2 \times 10^{15}$ Hz)

$$n(\text{Si}) = 4 \quad (1.11 \text{ eV})$$

$$n(\text{Ge}) = 4 \quad (0.66 \text{ eV})$$

$$n(\text{GaAs}) = 4 \quad (1.43 \text{ eV})$$

$$\left(\begin{array}{l} \omega_0 \sim 2 \times 10^{15} \text{ Hz} \\ \omega \sim 3 - 5 \times 10^{15} \text{ Hz} \end{array} \right)$$

(Because visible light uniformly transmit into Si, Ge, GaAs, they appear silver-white, but much darker!)

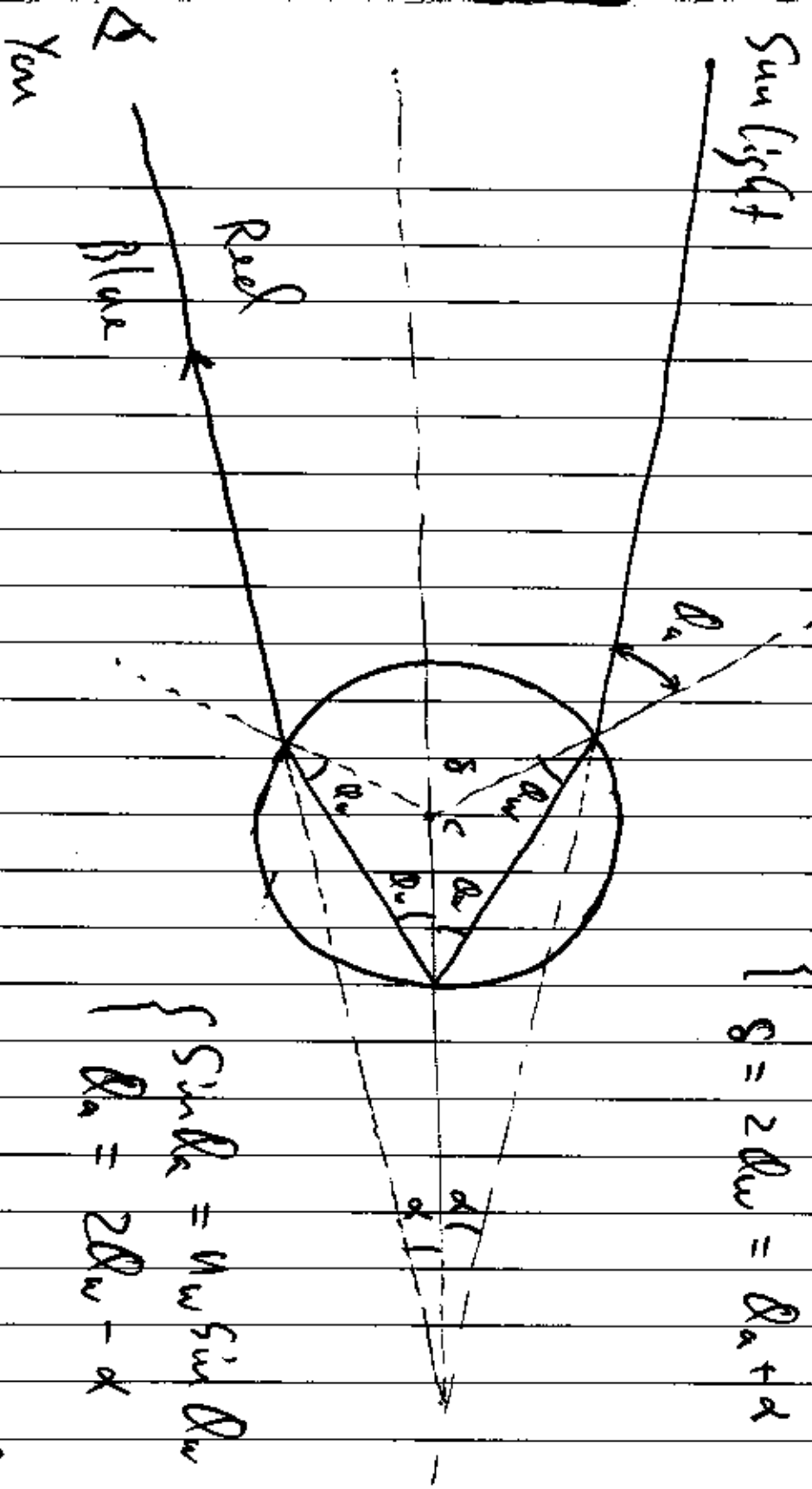

$$\begin{cases} \sin \theta_a = n_w \sin \theta_w \\ \theta_a = 2\theta_w = \theta_a + \alpha \end{cases}$$

$$\begin{cases} \sin \theta_a = n_w \sin \theta_w \\ \theta_a = 2\theta_w - \alpha \end{cases}$$

$$n_w \rightarrow \alpha = 22^\circ$$

$n_w \uparrow, \alpha(n_w) \downarrow$ (You look down to see it)
 (Blaze)

3. Optical constants in anisotropic media:

(Examples: quartz, calcite, liquid crystals, etc.)

In anisotropic media, the spring constant along the three principal axes (\hat{x} , \hat{y} , \hat{z}) are not equal:

$$M \frac{d^2x}{dt^2} = -K_x x - MP_x \frac{dx}{dt} + \rho E_x$$

$$M \frac{d^2y}{dt^2} = -K_y y - MP_y \frac{dy}{dt} + \rho E_y$$

$$M \frac{d^2z}{dt^2} = -K_z z - MP_z \frac{dz}{dt} + \rho E_z$$

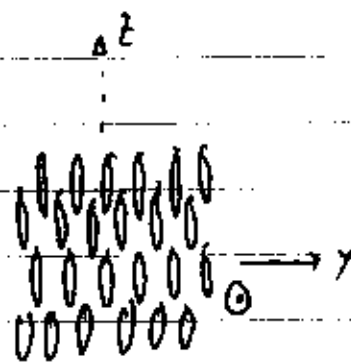

Dielectric tensor ϵ

$$\epsilon_{xx} = 1 + \frac{\omega_p^2}{\omega_x^2 - \omega^2 - \omega \beta_x i}$$

$$\epsilon_{yy} = 1 + \dots$$

$$\epsilon_{zz} = 1 + \dots$$

$K_{xx} = K_{yy} < K_{zz}$

① Uniaxial materials: $\epsilon_{xx} = \epsilon_{yy} \neq \epsilon_{zz}$ axis
 \hat{z} axis called optic axis

② Biaxial materials: $\epsilon_{xx} \neq \epsilon_{yy}$, $\epsilon_{xx} \neq \epsilon_{zz}$, $\epsilon_{yy} \neq \epsilon_{zz}$
 no optic axis

③ isotropic materials: $\epsilon_{xx} = \epsilon_{yy} = \epsilon_{zz}$

(Examples: liquids, amorphous solids, many crystals)

With x, y, z along the three principal axes of the material,

$$\begin{pmatrix} D_x \\ D_y \\ D_z \end{pmatrix} = \begin{pmatrix} \epsilon_{xx} & 0 & 0 \\ 0 & \epsilon_{yy} & 0 \\ 0 & 0 & \epsilon_{zz} \end{pmatrix} \begin{pmatrix} E_x \\ E_y \\ E_z \end{pmatrix}$$

$$\vec{D} = \epsilon \cdot \vec{E}$$

Optical dielectric constant for homogeneous, optically active materials

(DNA, sugar, quartz, etc.)

Since a helix looks exactly the same when you into either end of it, in any cartesian coordinate frame with a fixed handedness (typically right-hand) the dielectric constant is expressed as a tensor,

$$\begin{pmatrix} D_x \\ D_y \\ D_z \end{pmatrix} = \begin{pmatrix} \epsilon & i\alpha & 0 \\ -i\alpha & \epsilon & 0 \\ 0 & 0 & \epsilon \end{pmatrix} \begin{pmatrix} E_x \\ E_y \\ E_z \end{pmatrix}$$

$$\vec{D} = \hat{\epsilon} \cdot \vec{E}$$

$$\epsilon_{xx} = \epsilon_{yy} = \epsilon_{zz} = \epsilon$$

$$\epsilon_{xy} = -\epsilon_{yx} = i\alpha$$

$$\epsilon_{xz} = \epsilon_{zx} = \epsilon_{yz} = \epsilon_{zy} \quad *$$

Optical dielectric constant for homogeneous, magnetic materials, with the magnetization M along $+\hat{z}$ -direction

$$\begin{pmatrix} D_x \\ D_y \\ D_z \end{pmatrix} = \begin{pmatrix} \epsilon & i\alpha M_z & 0 \\ -i\alpha M_z & \epsilon & 0 \\ 0 & 0 & \epsilon \end{pmatrix} \begin{pmatrix} E_x \\ E_y \\ E_z \end{pmatrix}$$

If \vec{M} reverses or when the coordinate frame goes through an inversion operation,

$$\begin{pmatrix} D_x \\ D_y \\ D_z \end{pmatrix} = \begin{pmatrix} \epsilon & -i\alpha M \\ i\alpha M & \epsilon & 0 \\ 0 & 0 & \epsilon \end{pmatrix} \begin{pmatrix} E_x \\ E_y \\ E_z \end{pmatrix}$$

Useful for magneto-optics, for material science and the optical reflection isolation, etc.

Polarization of light

$\vec{E}(\vec{r}, t)$ is, after all, a vector wave. The vector nature is described in terms the polarization state of $\vec{E}(\vec{r}, t)$.

$\vec{E}(\vec{r}, t)$ is polarized: if two orthogonal, linear components that make up $\vec{E}(\vec{r}, t)$ vary with time synchronously

$\vec{E}(\vec{r}, t)$ is unpolarized: if two orthogonal, linear components vary with time randomly

$\vec{E}(\vec{r}, t)$ is partially polarized: if it contains a polarized part and an unpolarized part.

Decomposition of $\vec{E}(\vec{r}, t)$ or $\vec{D}(\vec{r}, t) = \vec{\epsilon} \cdot \vec{E}(\vec{r}, t)$ into two orthogonal, linear, components that are perpendicular to \vec{k} (direction of phase propagation)
(In anisotropic materials, only \vec{D} is perpendicular to \vec{k})

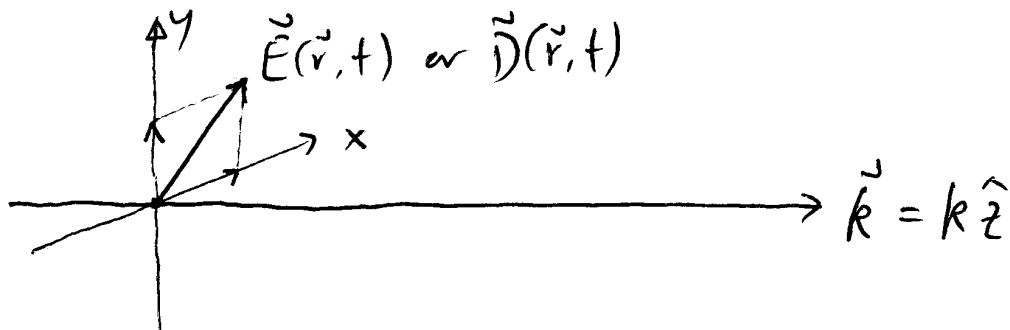

In x-y coordinate frame,

$$\vec{E}(\vec{r}, t) = \hat{x} E_{x_0}(\vec{r}, t) \cos[\phi_x(\vec{r}, t) - \omega t] \quad (\bar{E}_{x_0} \geq 0) \\ + \hat{y} E_{y_0}(\vec{r}, t) \cos[\phi_y(\vec{r}, t) - \omega t] \quad (\bar{E}_{y_0} \geq 0)$$

For unpolarized light, $\phi_y(\vec{r}, t) - \phi_x(\vec{r}, t)$ varies randomly and/or $E_{x_0}(\vec{r}, t)/E_{y_0}(\vec{r}, t)$ varies randomly.

For polarized light, $\phi_y(\vec{r}, t) - \phi_x(\vec{r}, t)$ is a constant of time, and $E_{x_0}(\vec{r}, t)/E_{y_0}(\vec{r}, t)$ or $E_{y_0}(\vec{r}, t)/E_{x_0}(\vec{r}, t)$ is also a constant of time.

Linearly polarized light: $\vec{E}(\vec{r}, t)$ traces out a straight line

$$\phi_y(\vec{r}, t) - \phi_x(\vec{r}, t) = m\pi, \quad m = 0, \pm 1, \pm 2, \dots$$

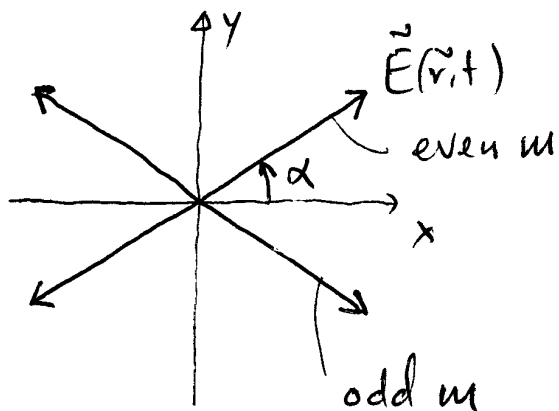

$$\tan \alpha = \frac{\bar{E}_{y_0}}{\bar{E}_{x_0}}$$

$$\vec{E}(\vec{r}, t) = \hat{x} E_{x_0} \cos[\phi_{x_0} - \omega t] \\ \pm \hat{y} E_{y_0} \cos[\phi_{x_0} - \omega t] \\ = \sqrt{E_{x_0}^2 + E_{y_0}^2} \cos[\phi_{x_0} - \omega t] \\ \cdot (\hat{x} \cos \alpha \pm \hat{y} \sin \alpha)$$

Circularly polarized light: $\vec{E}(\vec{r}, t)$ traces out a circle

$$\phi_y(\vec{r}, t) - \phi_x(\vec{r}, t) = 2m\pi \pm \frac{\pi}{2}, \quad m = 0, \pm 1, \pm 2, \dots$$

$$\bar{E}_{x_0}(\vec{r}, t) = \bar{E}_{y_0}(\vec{r}, t)$$

Left-circularly polarized light: (counter-clockwise)

$$\phi_y(\vec{r}, t) - \phi_x(\vec{r}, t) = 2m\pi + \frac{\pi}{2}$$

$$\vec{E}(\vec{r}, t) = \hat{x} \bar{E}_{x_0} \cos(\omega t - \phi_x) + \hat{y} \bar{E}_{y_0} \cos(\omega t - \phi_x - \frac{\pi}{2})$$

$$= \hat{x} \bar{E}_{x_0} \cos(\omega t - \phi_x) + \hat{y} \bar{E}_{x_0} \sin(\omega t - \phi_x)$$

$$= E_{x_0} \left[\hat{x} \cos(\omega t - \phi_x) + \hat{y} \sin(\omega t - \phi_x) \right]$$

unit vector that rotates ccw
at angular frequency ω

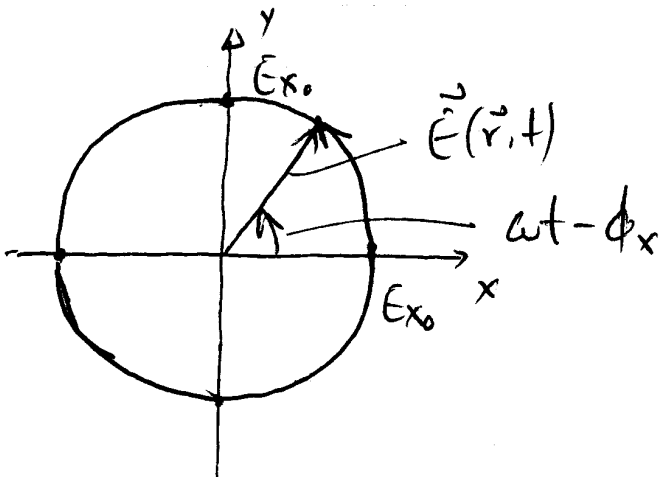

Right-circularly polarized light: (clockwise)

$$\phi_y(\vec{r}, t) - \phi_x(\vec{r}, t) = 2\omega t - \frac{\pi}{2}$$

$$\begin{aligned}\vec{E}(\vec{r}, t) &= \hat{x} E_{x0} \cos(\omega t - \phi_x(\vec{r}, t)) + \hat{y} E_{y0} \cos(\omega t - \phi_x + \frac{\pi}{2}) \\ &= E_{x0} \left[\hat{x} \cos[\phi_x - \omega t] + \hat{y} \sin[\phi_x - \omega t] \right]\end{aligned}$$

unit vector that rotates clockwise
at angular velocity ω

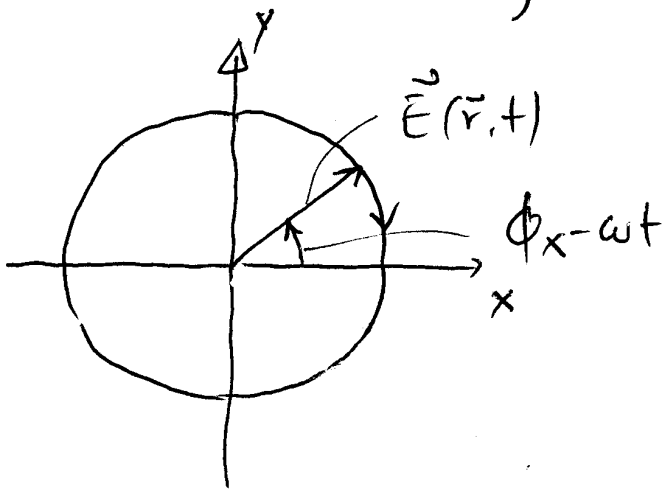

Elliptically polarized light: $\vec{E}(\vec{r}, t)$ traces out an ellipse.

$$\phi_y(\vec{r}, t) - \phi_x(\vec{r}, t) = 2m\pi \pm \frac{\pi}{2}$$

$$\bar{E}_{x_0}(\vec{r}, t) \neq \bar{E}_{y_0}(\vec{r}, t)$$

$$\phi_y(\vec{r}, t) - \phi_x(\vec{r}, t) = 2m\pi + \frac{\pi}{2} :$$

$$\vec{E}(\vec{r}, t) = \underbrace{\hat{x} E_{x_0} \cos(\omega t - \phi_{x_0})}_{x(t)} + \underbrace{\hat{y} E_{y_0} \sin(\omega t - \phi_{x_0})}_{y(t)}$$

$$\frac{x^2(t)}{E_{x_0}^2} + \frac{y^2(t)}{E_{y_0}^2} = 1 \quad (\text{equation of an ellipse})$$

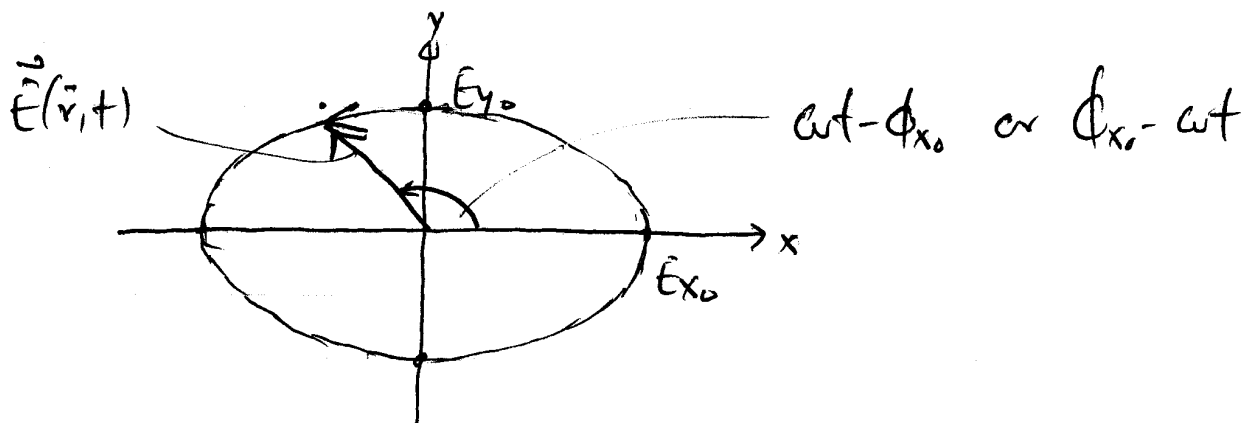

$$\phi_y(\vec{r}, t) - \phi_x(\vec{r}, t) = 2m\pi - \frac{\pi}{2} :$$

$$\vec{E}(\vec{r}, t) = \underbrace{\hat{x} E_{x_0} \cos(\phi_{x_0} - \omega t)}_{x(t)} + \underbrace{\hat{y} E_{y_0} \sin(\phi_{x_0} - \omega t)}_{y(t)}$$

Generally, we have an elliptically polarized light with

$$\begin{cases} \phi_y(\vec{r}, t) - \phi_x(\vec{r}, t) \equiv \Delta\phi \text{ arbitray (but fixed)} \\ \bar{E}_{x0}, \bar{E}_{y0} \text{ arbitray } (\bar{E}_{x0}/\bar{E}_{y0} \text{ fixed}) \end{cases}$$

$$\vec{E}(\vec{r}, t) = \hat{x} \bar{E}_{x0} \cos(\phi_x - \omega t) + \hat{y} \bar{E}_{y0} \cos(\phi_x - \omega t + \Delta\phi)$$

traces out an ellipse that is enclosed in a box of $2\bar{E}_{x0} \times 2\bar{E}_{y0}$. The principal axis is tilted with respect to the x-axis by θ :

$$\tan 2\theta = \frac{2\bar{E}_{x0}\bar{E}_{y0} \cos \Delta\phi}{\bar{E}_{x0}^2 - \bar{E}_{y0}^2}$$

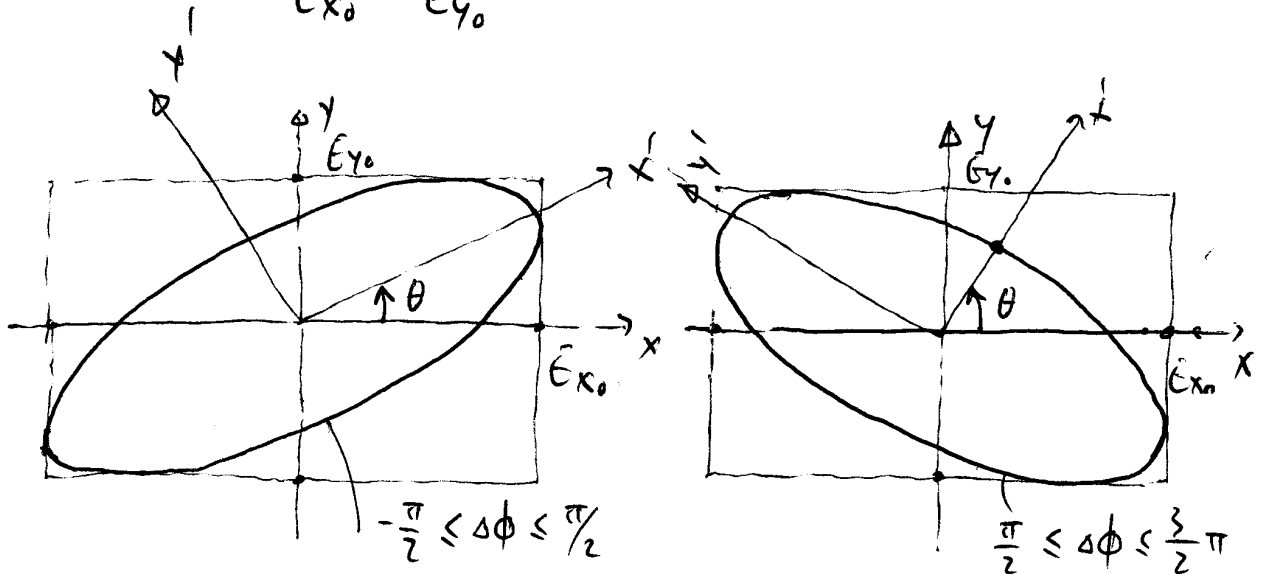

To determine whether it "rotates" clockwise or not, evaluate $d\bar{E}_y(t)/dt$ at $\phi_x - \omega t = 0$:

$$\frac{d\bar{E}_y(t)}{dt} \Big|_{\phi_x - \omega t = 0} = \omega \bar{E}_{y0} \sin \Delta\phi \begin{cases} \text{clockwise: } \pi < \Delta\phi < 2\pi \\ \text{ccw: } 0 < \Delta\phi < \pi \end{cases}$$

2. Jones vector representation of polarized light:

$$\begin{aligned}\vec{E}(\vec{r}, t) &= e^{ikz - i\omega t} (\hat{x} E_{x0} e^{i\phi_x} + \hat{y} E_{y0} e^{i\phi_y}) \\ &= e^{ikz - i\omega t} (\hat{x}, \hat{y}) \begin{pmatrix} E_{x0} e^{i\phi_x} \\ E_{y0} e^{i\phi_y} \end{pmatrix}\end{aligned}$$

Jones vector of $\vec{E}(\vec{r}, t)$:

$$\tilde{E}_0 = \begin{pmatrix} E_{x0} e^{i\phi_x} \\ E_{y0} e^{i\phi_y} \end{pmatrix} = E_{x0} e^{i\phi_x} \begin{pmatrix} 1 \\ \frac{E_{y0}}{E_{x0}} e^{i(\phi_y - \phi_x)} \end{pmatrix}$$

Since only the relative phase $\phi_y - \phi_x$ and the relative magnitude E_{y0}/E_{x0} determine the state of polarization of $\vec{E}(\vec{r}, t)$, Jones vector \tilde{E}_0 is always normalized, and only the second component carries the phase factor:

$$\tilde{E}_0 = \begin{pmatrix} \cos\alpha \\ e^{i(\phi_y - \phi_x)} \sin\alpha \end{pmatrix} \quad \tan\alpha = \frac{E_{y0}}{E_{x0}}$$

(i) Linearly polarized light:

$$\phi_y - \phi_x = 0, \quad \tilde{E}_0 = \begin{pmatrix} \cos\alpha \\ \sin\alpha \end{pmatrix}$$

$$\phi_y - \phi_x = \pi, \quad \tilde{E}_0 = \begin{pmatrix} \cos \alpha \\ -\sin \alpha \end{pmatrix}$$

(ii) Circularly polarized light

Left-circularly polarized light:

$$\phi_y - \phi_x = \frac{\pi}{2} : \quad \tilde{E}_0 = \frac{1}{\sqrt{2}} \begin{pmatrix} 1 \\ i \end{pmatrix}$$

Right-circularly polarized light:

$$\phi_y - \phi_x = -\frac{\pi}{2} : \quad \tilde{E}_0 = \frac{1}{\sqrt{2}} \begin{pmatrix} 1 \\ -i \end{pmatrix}$$

(iii) Elliptically polarized light:

Left-elliptically polarized light:

$$\tilde{E}_0 = \begin{pmatrix} \cos \alpha \\ e^{i(\phi_y - \phi_x)} \sin \alpha \end{pmatrix}, \quad 0 < \phi_y - \phi_x < \pi$$

$$= \frac{1}{\sqrt{A^2 + B^2 + C^2}} \begin{pmatrix} A \\ B + iC \end{pmatrix} \quad (A, C, > 0)$$

Right-elliptically polarized light.

$$\tilde{E}_0 = \begin{pmatrix} \cos \alpha \\ e^{i\phi_y - i\phi_x} \sin \alpha \end{pmatrix} \quad \pi < \phi_y - \phi_x < 2\pi$$

$$= \frac{1}{\sqrt{A^2 + B^2 + c^2}} \begin{pmatrix} A \\ B - ic \end{pmatrix} \quad (A, c > 0)$$

Example: Analysis of the Jones vector given by

$$\begin{pmatrix} 3 \\ 2+i \end{pmatrix} = \begin{pmatrix} 3 \\ \sqrt{5} e^{i26.6^\circ} \end{pmatrix} = \sqrt{14} \cdot \begin{pmatrix} 3/\sqrt{14} \\ \sqrt{5/14} e^{i26.6^\circ} \end{pmatrix}$$

$$E_{x0} = 3, \quad E_{y0} = \sqrt{2^2 + 1} = \sqrt{5}$$

$$\phi_y - \phi_x = \tan^{-1} \frac{1}{2} = 26.6^\circ \Rightarrow 0 < \phi_y - \phi_x < 180^\circ$$

\Rightarrow left elliptically polarized

the inclination angle of the principal axis

$$\theta = \frac{1}{2} \tan^{-1} \frac{2 \times 3 \times \sqrt{5} \times \cos(26.6^\circ)}{3^2 - 5} = 35.8^\circ$$

Equation of the ellipse:

$$\frac{E_x^2}{E_{x0}^2} + \frac{E_y^2}{E_{y0}^2} - 2 \frac{E_x}{E_{x0}} \frac{E_y}{E_{y0}} \cos \varphi = \sin^2 \varphi \quad (\varphi = \phi_y - \phi_x)$$

$$\frac{E_x^2}{5} + \frac{E_y^2}{5} - 0.267 E_x E_y = 0.2$$

3. Mathematical representation of polarizers and wave plates:
Jones Matrix

Linear polarizer:

A device which allows one linear polarized component to pass through and rejects the orthogonally linear polarized component. The direction of the passing polarization is the transmission axis TA.

Jones matrix of a linear polarizer with TA along \hat{x} :

$$M_x = \begin{pmatrix} 1 & 0 \\ 0 & 0 \end{pmatrix}$$

So that

$$\tilde{E}_{\text{after}} = M_x \tilde{E}_{\text{before}} = \begin{pmatrix} E_{x0} \\ 0 \end{pmatrix} \Rightarrow \text{losing energy}$$

Similarly, when TA is along \hat{y} :

$$M_y = \begin{pmatrix} 0 & 0 \\ 0 & 1 \end{pmatrix}$$

Linear polarizer with TA at θ from \hat{x} -axis

$$M(\theta) = \begin{pmatrix} \cos^2 \theta & \sin \theta \cos \theta \\ \sin \theta \cos \theta & \sin^2 \theta \end{pmatrix}$$

$$M(\theta + \frac{\pi}{2}) \Big|_{\text{cross-polarizer}} = \begin{pmatrix} \sin^2 \theta & -\sin \theta \cos \theta \\ -\sin \theta \cos \theta & \cos^2 \theta \end{pmatrix}$$

Easily proved by making sure $M(\theta) \begin{pmatrix} \cos \theta \\ \sin \theta \end{pmatrix} = \begin{pmatrix} \cos \theta \\ \sin \theta \end{pmatrix}$, $M(\theta) \begin{pmatrix} -\sin \theta \\ \cos \theta \end{pmatrix} = 0$ *

Passing an arbitrarily polarized light through a linear polarizer:

$$\tilde{E}_{inc} = \begin{pmatrix} E_{x0} e^{i\phi_x} \\ E_{y0} e^{i\phi_y} \end{pmatrix}$$

$$\tilde{E}_{out} = M(\theta) \tilde{E}_{inc} = \begin{pmatrix} \cos^2 \theta E_{x0} e^{i\phi_x} + \sin \theta \cos \theta E_{y0} e^{i\phi_y} \\ \sin \theta \cos \theta E_{x0} e^{i\phi_x} + \sin^2 \theta E_{y0} e^{i\phi_y} \end{pmatrix}$$

$$= \begin{pmatrix} \cos \theta E_{x0} e^{i\phi_x} + \sin \theta E_{y0} e^{i\phi_y} \\ \sin \theta E_{x0} e^{i\phi_x} + \cos \theta E_{y0} e^{i\phi_y} \end{pmatrix} \begin{pmatrix} \cos \theta \\ \sin \theta \end{pmatrix} *$$

Phase-retarding plate (phase-retarder):

Introducing a relative phase shift between the two electric field components along the fast axis (FA) and the slow axis (SA).

Let FA along x , SA along y : ($n_y = n_s > n_x = n_f$)

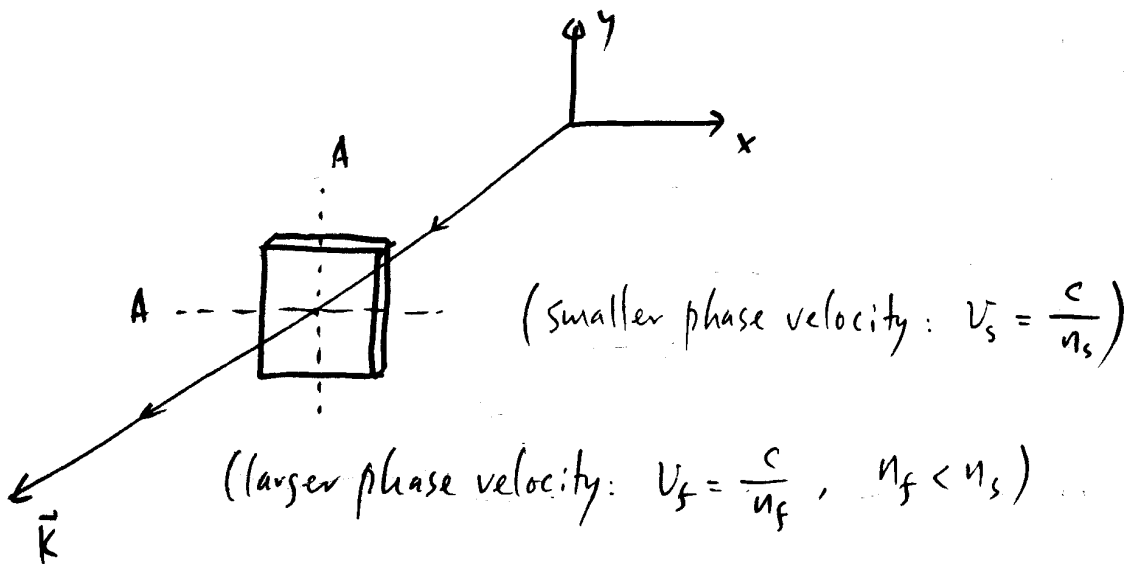

$$\tilde{\mathbf{E}}_{\text{before}} = \begin{pmatrix} \cos \alpha \\ e^{i(\phi_y - \phi_x)} \sin \alpha \end{pmatrix}$$

$$M (\text{phase-retarder}) = \begin{pmatrix} e^{i\phi_x} & 0 \\ 0 & e^{i\phi_y} \end{pmatrix}$$

$$\tilde{\mathbf{E}}_{\text{after}} = \begin{pmatrix} \cos \alpha e^{i\phi_x} \\ e^{i(\phi_y - \phi_x) + i\phi_y} \sin \alpha \end{pmatrix}$$

made with anisotropic materials

Quarter-wave plates:

$$\epsilon_y - \epsilon_x = \pm \frac{\pi}{2} + 2m\pi = \frac{2\pi}{\lambda} \left(m\lambda \pm \frac{\lambda}{4} \right)$$

$$M_{\lambda/4} = e^{-i\pi/4} \begin{pmatrix} 1 & 0 \\ 0 & i \end{pmatrix} \quad (\epsilon_y - \epsilon_x = \frac{\pi}{2} + 2m\pi)$$

$$M_{-\lambda/4} = e^{i\pi/4} \begin{pmatrix} 1 & 0 \\ 0 & -i \end{pmatrix} \quad (\epsilon_y - \epsilon_x = -\frac{\pi}{2} + 2m\pi)$$

Starting with a linearly polarized light along 45° from FA (\hat{x} -axis).

$$\tilde{\mathbf{E}}_{\text{before}} = \frac{1}{\sqrt{2}} \begin{pmatrix} 1 \\ 1 \end{pmatrix}$$

$$\tilde{\mathbf{E}}_{\text{after}} = \frac{1}{\sqrt{2}} \begin{pmatrix} 1 \\ \pm i \end{pmatrix} \Rightarrow \text{Circularly polarized light.}$$

If $\lambda/4$ -plate's SA makes θ about y , in x - y frame,

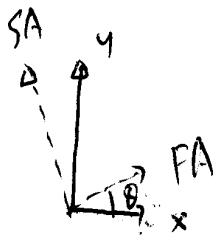

$$\tilde{\mathbf{E}}_{\text{after}} = \begin{pmatrix} \cos \theta & -\sin \theta \\ \sin \theta & \cos \theta \end{pmatrix} \begin{pmatrix} 1 & 0 \\ 0 & i \end{pmatrix} \begin{pmatrix} \cos \theta & \sin \theta \\ -\sin \theta & \cos \theta \end{pmatrix} \tilde{\mathbf{E}}_{\text{in}}$$

$$\begin{pmatrix} x' \\ y' \end{pmatrix} = \begin{pmatrix} \cos \theta & \sin \theta \\ -\sin \theta & \cos \theta \end{pmatrix} \begin{pmatrix} x \\ y \end{pmatrix}; \quad \begin{pmatrix} x \\ y \end{pmatrix} = \begin{pmatrix} \cos \theta & -\sin \theta \\ \sin \theta & \cos \theta \end{pmatrix} \begin{pmatrix} x' \\ y' \end{pmatrix}$$

$$M_{\lambda/4}(\theta) = \begin{pmatrix} \cos\theta & -\sin\theta \\ \sin\theta & \cos\theta \end{pmatrix} \begin{pmatrix} 1 & 0 \\ 0 & i \end{pmatrix} \begin{pmatrix} \cos\theta & \sin\theta \\ -\sin\theta & \cos\theta \end{pmatrix}$$

$$= \begin{pmatrix} \cos^2\theta + i\sin^2\theta & \sin\theta\cos\theta(1-i) \\ \sin\theta\cos\theta(1-i) & \sin^2\theta + i\cos^2\theta \end{pmatrix}$$

$$M_{\lambda/4}(\theta) \tilde{E}_L = e^{i\theta} \begin{pmatrix} \cos(\theta - \pi/4) \\ \sin(\theta - \pi/4) \end{pmatrix}, \quad \alpha = \theta - \pi/4$$

$$M_{\lambda/4}(\theta) \tilde{E}_R = e^{-i\theta} \begin{pmatrix} \cos(\theta + \pi/4) \\ \sin(\theta + \pi/4) \end{pmatrix}, \quad \alpha = \theta + \pi/4$$

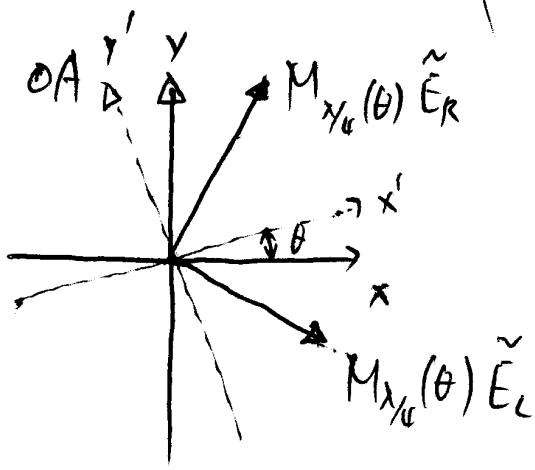

Half-wave plate:

$$\epsilon_y - \epsilon_x = \pm \pi = \pm \left(\frac{2\pi}{\lambda}\right) \cdot \frac{\lambda}{2}$$

$$M_{\lambda/2} = e^{-i\pi/2} \begin{pmatrix} 1 & 0 \\ 0 & -1 \end{pmatrix}, \quad \epsilon_y - \epsilon_x = \pi$$

$$M_{\lambda/2} = e^{+i\pi/2} \begin{pmatrix} 1 & 0 \\ 0 & -1 \end{pmatrix}, \quad \epsilon_y - \epsilon_x = -\pi$$

starting with a linearly polarized light along θ from SA w/ x-axis,

$$\vec{E}_{\text{before}} = \begin{pmatrix} \cos\theta \\ \sin\theta \end{pmatrix}$$

$$\vec{E}_{\text{after}} = \begin{pmatrix} \cos\theta \\ -\sin\theta \end{pmatrix}: \quad \text{a linearly polarized light along } -\theta \text{ from SA.}$$

By rotating SA from the incoming linearly polarized light by θ , the outgoing light will be linearly polarized, but rotated by 2θ *

$$M_{\lambda/2}(\theta) = \begin{pmatrix} \cos 2\theta & \sin 2\theta \\ \sin 2\theta & -\cos 2\theta \end{pmatrix}$$

Rotator:

Rotate a linearly polarized light by a fixed angle β regardless the initial orientation of the linear polarization.

$$\tilde{E}_{inc} = \begin{pmatrix} \cos\theta \\ \sin\theta \end{pmatrix}$$

$$M_{rotator}(\beta) = \begin{pmatrix} \cos\beta & -\sin\beta \\ \sin\beta & \cos\beta \end{pmatrix}$$

made with optically active
or magnetic materials

$$\tilde{E}_{after} = M_{rotator}(\beta) \begin{pmatrix} \cos\theta \\ \sin\theta \end{pmatrix} = \begin{pmatrix} \cos(\theta+\beta) \\ \sin(\theta+\beta) \end{pmatrix}^*$$

System Jones Matrix:

$$M_{1/2}(\alpha) = \begin{pmatrix} \cos 2\alpha & \sin 2\alpha \\ \sin 2\alpha & -\cos 2\alpha \end{pmatrix}$$

If the principal axes of wave plates make angles (α 's) with respect to the x -axis, one needs to perform proper coordinate transformation

$$\begin{aligned} \tilde{E}_{after} &= M_4 M_3 M_2 M_1 \tilde{E}_{inc} \\ &= M_{system} \tilde{E}_{inc} \end{aligned}$$

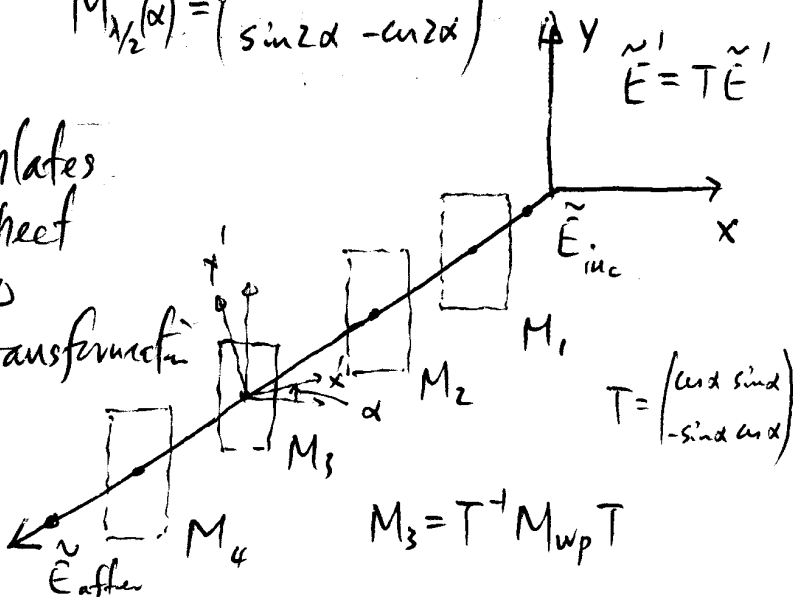

$$M_3 = T^{-1} M_{wp} T$$

Light propagation in Anisotropic media, Optically active media, magnetic media — Crystal Optics

In isotropic materials (that we have implicitly assumed so far), only one dielectric constant ϵ and thus one refractive index $n = \sqrt{\epsilon}$ (real or complex alike) characterizes the optical response.

As a result, $\vec{D} = \epsilon \vec{E} \parallel \vec{E}$, $\vec{E} \cdot \vec{k} = 0$. \vec{E} can be linearly polarized, circular polarized, or elliptically polarized plane wave with the same refractive index. Since there are two "linearly" independent vectors that are orthogonal to \vec{k} , one can state that in an isotropic medium, given the direction of the phase propagation \hat{k} , there are two orthogonal eigenmodes of plane-wave electromagnetic field with the same refractive index $n = \sqrt{\epsilon}$. These two eigenmodes can be a pair of linear polarization components (in the presence of a surface, we choose TE and TM), or right-circular and left-circular polarization components, or a pair of orthogonal elliptically polarized components:

$$\vec{E}_1 = \begin{pmatrix} a \\ ib \end{pmatrix}, \quad \vec{E}_2 = \begin{pmatrix} b \\ -ia \end{pmatrix}$$

In anisotropic materials, or optically active materials, or magnetic materials, we can still have plane-wave harmonic electromagnetic field. But, given a direction of phase propagation \hat{k} , we again expect two algebraically (i.e., "linearly") independent vectors with their respective refractive indices. These two vectors are generally two orthogonal, elliptically polarized light components, and the principal axes of the ellipses are fixed by \hat{k} and the principal axes of the crystalline materials or of the helix (optically active materials) or of the magnetization (magnetic materials).

The refractive indices and the polarization states of the two eigenmodes for a given \hat{k} are uniquely determined from the Maxwell's equations.

We will consider three cases in their respective principal coordinate frames

Uniaxial materials:

$$\begin{pmatrix} D_x \\ D_y \\ D_z \end{pmatrix} = \begin{pmatrix} \epsilon_0 & 0 & 0 \\ 0 & \epsilon_0 & 0 \\ 0 & 0 & \epsilon_e \end{pmatrix} \begin{pmatrix} E_x \\ E_y \\ E_z \end{pmatrix}$$

(\hat{z} : optic axis, OA)

Optical active / magnetic media

$$\begin{pmatrix} D_x \\ D_y \\ D_z \end{pmatrix} = \begin{pmatrix} \epsilon_0 & i\alpha & 0 \\ -i\alpha & \epsilon_0 & 0 \\ 0 & 0 & \epsilon_0 \end{pmatrix} \begin{pmatrix} E_x \\ E_y \\ E_z \end{pmatrix}$$

(\vec{M} or helix axis $\parallel \hat{z}$)

What are we going to get in the end?

Uniaxial materials

Let \hat{k} make θ from the positive z -axis. Then \hat{k} and z -axis define a plane, x - z plane

One eigenmode, the ordinary ray (o-ray), is linearly polarized with the electric field \vec{E}_o perpendicular to this plane, and the refractive index

$n_o = \sqrt{\epsilon_o}$, $\vec{E}_o = \hat{y} E_o \cos\left(\frac{2\pi}{\lambda} n_o \hat{k} \cdot \vec{r} - \omega t\right)$
being independent of θ

The other eigenmode, the extraordinary ray (e-ray), is also linearly polarized with the electric field \vec{E}_e in the plane, and the refractive index $n_e(\theta)$ given by

$$\frac{1}{n_e(\theta)^2} = \frac{\cos^2 \theta}{\epsilon_o} + \frac{\sin^2 \theta}{\epsilon_e}$$

i.e., dependent on θ

$$\vec{E}_e = \hat{x} (n_e^2(\theta) \sin^2 \theta - \epsilon_e) + \hat{z} n_e^2(\theta) \cos \theta \sin \theta$$

up to a constant. Note $\vec{E}_e \cdot \hat{k} \neq 0$

Optically active / magnetic materials

Let $\hat{k} = (\sin\theta, 0, \cos\theta)$ make θ from the positive z -axis.

One eigenmode is "left-circulating" elliptically polarized with a refractive index

$$n_L(\theta) \approx \sqrt{\epsilon_0 - \alpha \cos\theta} \quad (\alpha \ll \epsilon_0)$$

and

$$\begin{aligned} \vec{E}_L(\theta) = & \hat{x} \cos\theta (\epsilon_0 \cos\theta + \alpha \sin^2\theta) + \hat{y} i (\epsilon_0 \cos\theta + \alpha \sin^2\theta) \\ & + \hat{z} (-) (\epsilon_0 - \alpha \cos\theta) \sin\theta \cos\theta \end{aligned}$$

The other eigenmode is "right-circulating" elliptically polarized with a refractive index

$$n_R \approx \sqrt{\epsilon_0 + \alpha \cos\theta} \quad (\alpha \ll \epsilon_0)$$

and

$$\begin{aligned} \vec{E}_R(\theta) = & \hat{x} \cos\theta (\epsilon_0 \cos\theta - \alpha \sin^2\theta) - \hat{y} i (\epsilon_0 \cos\theta - \alpha \sin^2\theta) \\ & + \hat{z} (-) (\epsilon_0 + \alpha \cos\theta) \cdot \sin\theta \cos\theta. \end{aligned}$$

For magnetic materials, when \vec{M} changes sign, α does as well!!

Special cases $\theta = 0$

When the light travels along the direction of the magnetization (\hat{z} -axis) or the helix,

$$v_L = \sqrt{\epsilon_0 - \alpha}$$

$$\vec{E}_L = \epsilon_0 (\hat{x}, \hat{y}) \begin{pmatrix} 1 \\ i \end{pmatrix}$$

$$v_R = \sqrt{\epsilon_0 + \alpha}$$

$$\vec{E}_R = \epsilon_0 (\hat{x}, \hat{y}) \begin{pmatrix} 1 \\ -i \end{pmatrix}$$

Formal proof for the case of uniaxial materials

$$\vec{E}(\vec{r}, t) = (\hat{x} E_x + \hat{y} E_y + \hat{z} E_z) e^{i\vec{k} \cdot \vec{r} - i\omega t}$$

$$\vec{k} = n(\theta) \frac{2\pi}{\lambda} (\hat{x} \sin\theta + \hat{z} \cos\theta)$$

$$\text{From } \nabla \times (\nabla \times \vec{E}) = \left(\frac{2\pi}{\lambda}\right)^2 \vec{E} \cdot \vec{E}$$

$$\vec{E} \cdot \vec{E} - n^2(\theta) \vec{E} + n^2(\theta) \hat{k} (\hat{k} \cdot \vec{E}) = 0$$

$$\vec{E} = \hat{x} E_x + \hat{y} E_y + \hat{z} E_z$$

$$\hat{k} = \hat{x} \sin\theta + \hat{z} \cos\theta$$

$$\hat{x}\text{-axis: } E_x (\epsilon_0 - n^2(\theta) \cos^2\theta) + E_z n^2(\theta) \sin\theta \cos\theta = 0$$

$$\hat{y}\text{-axis: } E_y (\epsilon_0 - n^2(\theta)) = 0$$

$$\hat{z}\text{-axis: } E_x n^2(\theta) \sin\theta \cos\theta + E_z (\epsilon_0 - n^2(\theta) \sin^2\theta) = 0$$

for a non-trivial solution for \vec{E} , we require

$$\begin{vmatrix} \epsilon_0 - n^2(\theta) \cos^2\theta & 0 & n^2(\theta) \sin\theta \cos\theta \\ 0 & \epsilon_0 - n^2(\theta) & 0 \\ n^2(\theta) \sin\theta \cos\theta & 0 & \epsilon_0 - n^2(\theta) \sin^2\theta \end{vmatrix} = 0$$

$$\text{or } (\epsilon_0 - n^2(\theta)) [\epsilon_0 \epsilon_0 - \epsilon_0 n^2(\theta) \sin^2\theta - \epsilon_0 n^2(\theta) \cos^2\theta] = 0$$

There are two solutions:

Ordinary ray \vec{E}_o with $\epsilon_o - n_o^2(\theta) = 0$:

$$n_o(\theta) = n_o = \sqrt{\epsilon_o} \quad (\text{independent of } \theta)$$

$$\vec{E}_o = \hat{y} E_o \quad (\text{as } E_x = 0, E_z = 0)$$

Extraordinary ray \vec{E}_e with

$$\epsilon_o \epsilon_e - \epsilon_o n_e^2(\theta) \sin^2 \theta - \epsilon_e n_o^2(\theta) \cos^2 \theta = 0$$

$$\frac{1}{n_e^2(\theta)} = \frac{\cos^2 \theta}{\epsilon_o} + \frac{\sin^2 \theta}{\epsilon_e}$$

$$\begin{aligned} \vec{E}_e &= (\dots) \left(\hat{x} n_o^2(\theta) \sin \theta \cos \theta + \hat{z} (n_o^2(\theta) \cos \theta - \epsilon_o) \right) \\ &= (\dots) \left((n_o^2(\theta) \sin^2 \theta - \epsilon_e) \hat{x} + n_o^2(\theta) \cos \theta \sin \theta \hat{z} \right) \end{aligned}$$

It is noteworthy that \vec{D}_e is perpendicular to \hat{k} ,

$$\vec{D}_e = \vec{\epsilon} \cdot \vec{E}_e = (\dots) \frac{\epsilon_o \epsilon_e \sin \theta}{\epsilon_o \cos^2 \theta + \epsilon_e \sin^2 \theta} (\hat{x} \cos \theta - \hat{z} \sin \theta)$$

which is perpendicular to $\hat{k} = \hat{x} \sin \theta + \hat{z} \cos \theta$.

Birefringence

Direction of energy flow $\vec{S} = \frac{1}{\mu_0} \vec{E} \times \vec{B}$ is not along the direction of phase propagation \hat{k} :

$$\hat{k} \times \vec{S} = \frac{1}{\mu_0} \hat{k} \times \left(\vec{E} \times \left(\frac{\eta}{c} \hat{k} \times \vec{E} \right) \right)$$

$$= \frac{\eta}{\mu_0 c} \hat{k} \times \left(\hat{k} (\vec{E}^2) - \vec{E} (\hat{k} \cdot \vec{E}) \right)$$

$$= \frac{\eta}{\mu_0 c} (\hat{k} \times \vec{E}) (\hat{k} \cdot \vec{E})$$

$$\neq 0$$

This causes problem (walk-off) in nonlinear optics.

Double refraction at the surface of uniaxial material

Generally it is complicated algebraically if the optic axis of the material is neither in the plane of incidence nor perpendicular to the plane of incidence.

We only consider the cases when either OA is in or perpendicular to the plane of incidence. In these cases, s- and p-polarized incident light will respectively only couple to either o-ray or e-ray in the uniaxial material.

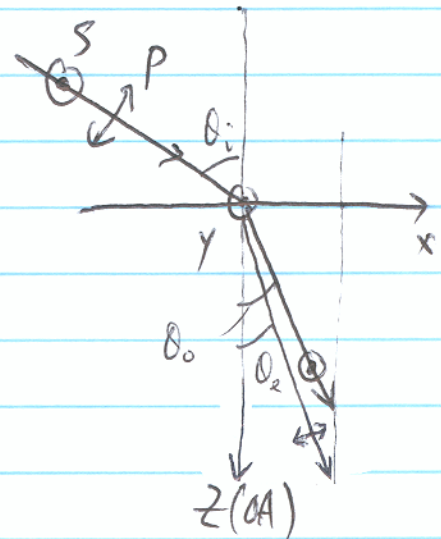
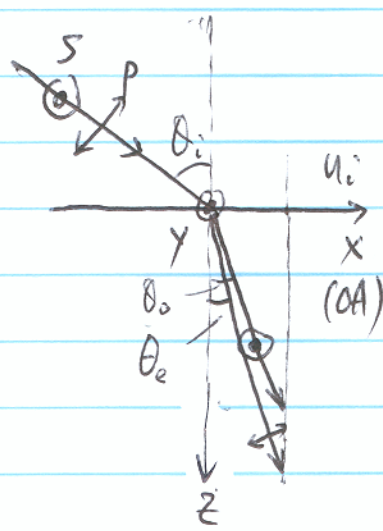
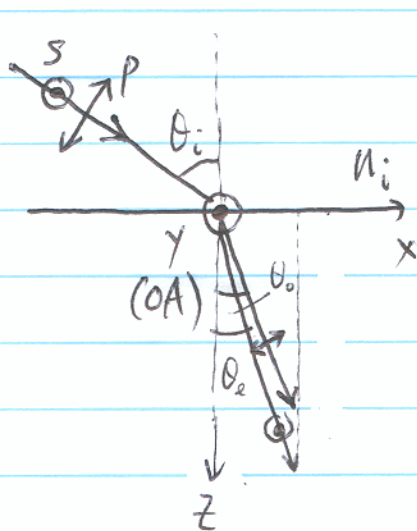

TE \rightarrow e-ray

TM \rightarrow o-ray

$$n_o \sin \theta_o = n_i \sin \theta_i$$

$$n_e \sin \theta_e = n_i \sin \theta_i$$

TE \rightarrow o-ray

TM \rightarrow e-ray

$$n_o \sin \theta_o = n_i \sin \theta_i$$

$$\sin \theta_e = \frac{n_o \sin \theta_o}{\sqrt{n_o^2 + (n_o^2 - n_e^2) \cos^2 \theta_o}}$$

TE \rightarrow o-ray

TM \rightarrow e-ray

$$n_o \sin \theta_o = n_i \sin \theta_i$$

$$\sin \theta_e = \frac{n_e \sin \theta_o}{\sqrt{n_e^2 + (n_o^2 - n_e^2) \sin^2 \theta_o}}$$

Linear polarizer made of uniaxial materials

— Effect of double refraction and internal reflection

Quartz crystal: $n_o = 1.544$
 $n_e = 1.553$
 $n_e > n_o$
 $\Delta n = n_e - n_o = 0.009$
Rejection $500:1$

Calcite crystal: $n_o = 1.658$
 $n_e = 1.486$
 $n_e < n_o$
 $\Delta n = n_o - n_e = 0.172$
Rejection $10^5:1$

Glan-Foucault polarizing prisms (Glan-Thompson)

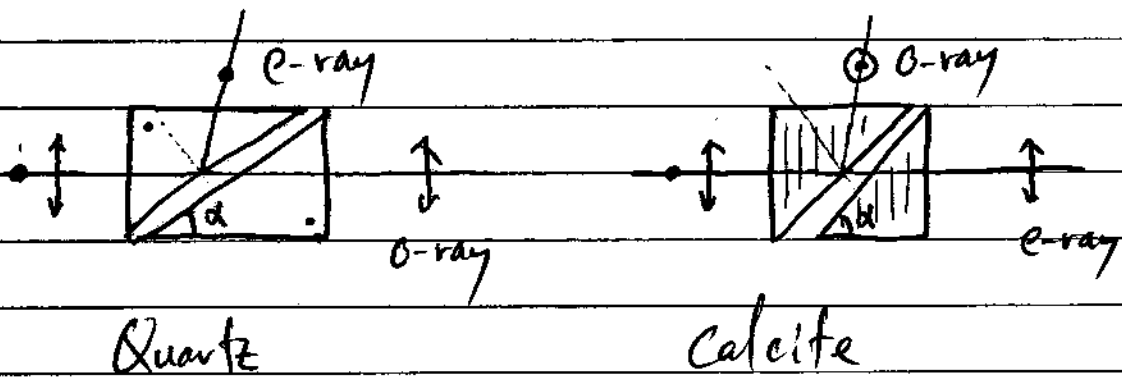

α 's are cut to totally reflect one while passing the other.

Rochan prism

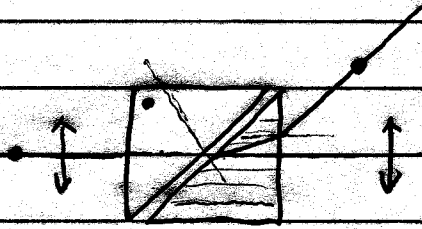

Quartz crystal
($n_e > n_o$)

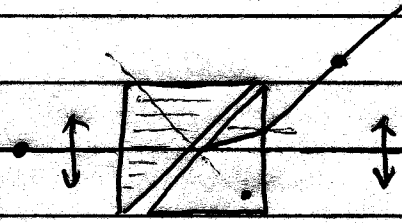

Calcite crystal
($n_e < n_o$)

In all these cases, the transmission axis (TA) is in the plane of incidence for the gap

7. Phase-retarding plates: (phase retarder)

Uniaxial crystal plates with optic axes in the planes of the plates.

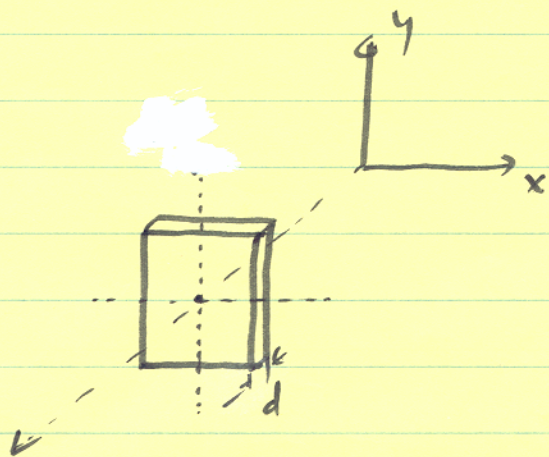

e-ray with \vec{E} along OA has a phase velocity

$$v_e = \frac{c}{n_e}$$

O-ray with \vec{E} perpendicular to OA has a phase velocity

$$v_o = \frac{c}{n_o}$$

Slow axis: direction of \vec{E} with smaller v (SA)

Fast axis: direction of \vec{E} with larger v . (FA)

\Rightarrow slow axis hosts the ray with larger index of refraction, and thus the ray which picks up extra, positive phase.

$$\phi(\text{SA}) - \phi(\text{FA}) = \frac{2\pi}{\lambda} d (n_{\text{large}} - n_{\text{small}}) > 0$$

Let \hat{x} along FA, \hat{y} along SA,

$$E_x(z+d) = E_x(z) e^{i\phi(\text{FA})}$$

$$E_y(z+d) = E_y(z) e^{i\phi(\text{SA})}$$

$$\therefore M = \begin{pmatrix} e^{i\phi(\text{FA})} & 0 \\ 0 & e^{i\phi(\text{SA})} \end{pmatrix}$$

$$\therefore M = \begin{pmatrix} 1 & 0 \\ 0 & e^{i\phi(\text{SA}) - i\phi(\text{FA})} \end{pmatrix} e^{i\phi(\text{FA})}$$

Quarter-wave plate: $\lambda/4$ -plate.

$$\phi(\text{SA}) - \phi(\text{FA}) = \frac{2\pi}{\lambda} d |n_o - n_e| = \left(m + \frac{1}{2}\right) \pi$$

$$M = \begin{pmatrix} 1 & 0 \\ 0 & \pm i \end{pmatrix}$$

Half-wave plate: $\lambda/2$ -plate

$$\phi(\text{SA}) - \phi(\text{FA}) = \frac{2\pi}{\lambda} d |n_o - n_e| = (2m+1)\pi, \quad M = \begin{pmatrix} 1 & 0 \\ 0 & -1 \end{pmatrix}$$

Rotation of linear polarization by optically active or magnetic materials

In optically active materials or magnetized materials, the eigenmodes of electromagnetic waves are elliptically polarized.

When the direction of phase propagation, \vec{k} , is along the magnetization or simply in an optically active and otherwise isotropic material, the two eigenmodes are circularly polarized with their respective refractive indices, n_L and n_R .

$$\vec{E}_L(z, t) = E_L \left[\hat{x} \cos\left(\omega t - \frac{2\pi}{\lambda} n_L z\right) + \hat{y} \sin\left(\omega t - \frac{2\pi}{\lambda} n_L z\right) \right]$$

or

$$\tilde{\vec{E}}_L(z, t) = E_L e^{i\left(\frac{2\pi}{\lambda} n_L z - \omega t\right)} \begin{pmatrix} 1 \\ i \end{pmatrix} \cdot \frac{1}{\sqrt{2}}$$

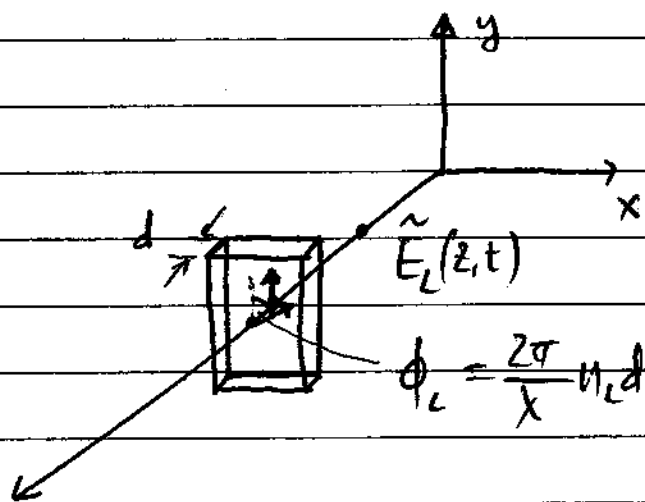

$$\vec{E}_R(z,t) = E_R \left[\hat{x} \cos\left(\frac{2\pi}{\lambda} v_R z - \omega t\right) + \hat{y} \sin\left(\frac{2\pi}{\lambda} v_R z - \omega t\right) \right]$$

or

$$\vec{E}_R(z,t) = E_R e^{i\frac{2\pi}{\lambda} v_R z - i\omega t} \begin{pmatrix} 1 \\ -i \end{pmatrix} \cdot \frac{1}{\sqrt{2}}$$

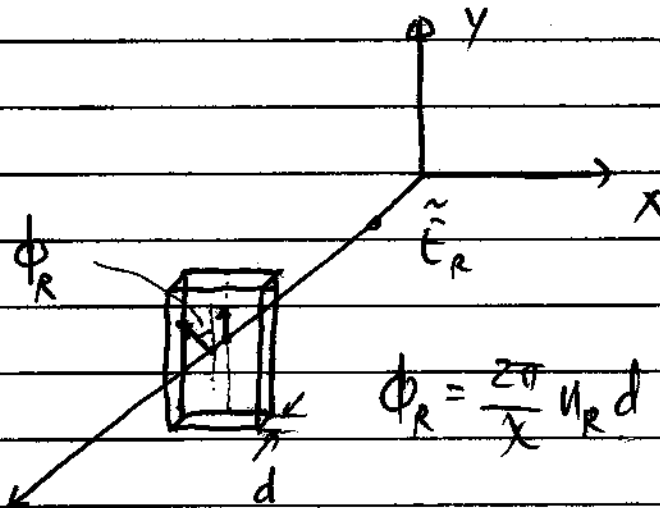

Decomposition of a linearly polarized light into two circularly polarized components of equal amplitude

$$\vec{E}(\theta) = \begin{pmatrix} \cos\theta \\ \sin\theta \end{pmatrix} = \frac{e^{-i\theta}}{\sqrt{2}} \frac{1}{\sqrt{2}} \begin{pmatrix} 1 \\ i \end{pmatrix} + \frac{e^{i\theta}}{\sqrt{2}} \frac{1}{\sqrt{2}} \begin{pmatrix} 1 \\ -i \end{pmatrix}$$

Particularly, when $\theta = 90^\circ$ (as shown)

$$\vec{E}(\theta=90^\circ) = \frac{(-i)}{\sqrt{2}} \frac{1}{\sqrt{2}} \begin{pmatrix} 1 \\ i \end{pmatrix} + \frac{i}{\sqrt{2}} \frac{1}{\sqrt{2}} \begin{pmatrix} 1 \\ -i \end{pmatrix}$$

Let $\phi_R = \frac{2\pi}{\lambda} n_R d$ be larger than $\phi_L = \frac{2\pi}{\lambda} n_L d$,

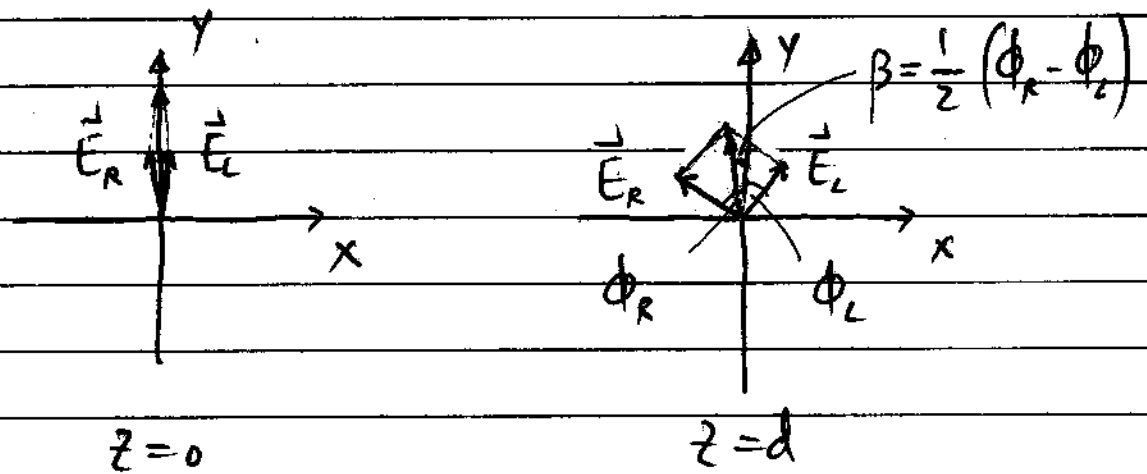

Rotator!

Jones matrix for a plate of an optically active or magnetized material with a thickness d

Let's derive it as we didn't do anything for the linear polarizer. Let

$$M = \begin{pmatrix} a & b \\ c & d \end{pmatrix}$$

We expect

$$M \begin{pmatrix} 1 \\ i \end{pmatrix} = e^{i\phi_L} \begin{pmatrix} 1 \\ i \end{pmatrix} = \begin{pmatrix} a + ib \\ c + id \end{pmatrix}$$

$$M \begin{pmatrix} 1 \\ -i \end{pmatrix} = e^{i\phi_R} \begin{pmatrix} 1 \\ -i \end{pmatrix} = \begin{pmatrix} a - ib \\ c - id \end{pmatrix}$$

Trivially,

$$a = \cos \beta \cdot e^{i \frac{1}{2} (\phi_R + \phi_L)}$$

$$b = -\sin \beta \cdot e^{i \frac{1}{2} (\phi_R + \phi_L)}$$

$$c = \sin \beta \cdot e^{i \frac{1}{2} (\phi_R + \phi_L)}$$

$$d = \cos \beta \cdot e^{i \frac{1}{2} (\phi_R + \phi_L)}$$

$$\beta = \frac{1}{2} (\phi_R - \phi_L)$$

So, ignoring the "unimportant" constant phase factor,

$$M = \begin{pmatrix} \cos \beta & -\sin \beta \\ \sin \beta & \cos \beta \end{pmatrix} \quad \beta = \frac{\pi d}{\lambda} (n_R - n_L)$$

a matrix of a rotator.

$$\text{With } \tilde{E}_{\text{inc}} = \begin{pmatrix} \cos \theta \\ \sin \theta \end{pmatrix},$$

$$\tilde{E}_{\text{out}} = M \tilde{E}_{\text{inc}} = e^{i \frac{1}{2} (\phi_R + \phi_L)} \begin{pmatrix} \cos(\theta + \beta) \\ \sin(\theta + \beta) \end{pmatrix}$$

$$\beta = \frac{1}{2} (\phi_R - \phi_L) = \frac{\pi}{\lambda} d (n_R - n_L)$$

Example

Quartz can be left-handed or right-handed. Typically, along the optic axis, the refractive indices for two circularly polarized light components are different,

$$\frac{\sigma}{\lambda} (n_R - n_L) \Big|_{7600\text{\AA}} = 8\pi \times 10^5 \text{ rad}/\mu\text{m}$$

With $d = 1\text{cm} = 10^4 \mu\text{m}$

$$\beta = \frac{\sigma}{\lambda} d (n_R - n_L) = 0.8\pi \text{ radians} = 144^\circ$$

$$n_R - n_L = 6.2 \times 10^{-5} \leq 10^{-4}$$